

**NOTE! - THIS MANUAL IS FOR A LEGACY-VERSION FIRMWARE/HARDWARE.
IF YOU ARE SEEKING THE LATEST MANUAL, THEN PLEASE VISIT OUR DOCUMENTATION
AND SUPPORT CENTER ON THE WEB: [HTTP://SCADMETRICS.COM/DOCS/DOCS.HTM](http://scadmetrics.com/docs/docs.htm)**

EtherMeter®

**FLOW METER GATEWAY FOR SCADA,
TELEMETRY, & BUILDING AUTOMATION SYSTEMS**
COVERED BY US PATENT NO. 8,219,214



Installation, Operation, and Maintenance Manual

Version 2.57.07

09 June 2021

AUTHORIZED SCADAMETRICS RESELLER

SCADAMetrics®
St. Louis, Missouri USA
scadmetrics.com

TABLE OF CONTENTS

<u>Ch.</u>	<u>Title</u>	<u>Page</u>
1	Introduction and Gallery	2
2	Recommended Skills And Tools	7
3	Specifications	8
4	Electrical Interface	12
5	Meter Compatibility	14
6	Sensus Protocol Meter Support	15
7	Neptune Protocol Meter Support	18
8	K-Frame Protocol Meter Support	21
9	Pulse Meter Support	24
10	PLC/RTU/Computer Interface	27
11	Radio Interface	30
12	Auxiliary I/O Channels	32
13	Setup and Diagnostic Utilities	36
14	MODBUS Protocol Support	51
15	DF1 and EtherNet/IP Protocol Support	58
16	ADAM-4000 Protocol Support	67
17	ASCII Protocol Support	73
18	Serial Display Protocol Support	76
19	HTTP Web Server	78
20	Telnet Server	80
21	Network Security	81
22	References	82
23	Limited Warranty	84
24	Firmware License	86

CONTACT:

SCADAmetrics

1133 POND ROAD
WILDWOOD, MO 63038
VOICE: 636.405.7101
FAX: 314.669.6970
scadmetrics.com

© 2008-2019 SCADAMETRICS
ALL RIGHTS RESERVED

Trademarks Referenced Within This Document:

Acculinx™ and eLinx™ are trademarks of Master Meter, Inc..
ADE® is a registered trademark of Badger Meter.
CIP™ is a trademark of ODVA.
Cyble™ is a trademark of Itron Corp.
EtherMeter®, SCADAmeter®, and SCADAmetrics® are trademarks of Navionics Research Inc dba SCADAmetrics
EtherNet/IP™ is a trademark of ControlNet International.
E-Coder™ and ProRead™ are trademarks of Neptune Technology Group.
HawkEye™ is a trademark of Metron Farnier, Inc.
HyperTerminal Private Edition™ is a trademark of Hilgrave Software.
ICE® is a registered trademark of Sensus Metering Systems.
InVISION™ is a trademark of Honeywell / Elster AMCO, Inc.
Lexar® is a registered trademark of SABIC Innovative Plastics.
MODBUS® is a registered trademark of Schneider Electric.
RSLinx™ is a trademark of Rockwell Automation.
Sensorlex® is a registered trademark of Dataforth Corp.
Tomahawk® Encoder is a registered trademark of RG3 Meter Company.
Windows® is a registered trademark of Microsoft Corporation.

1 INTRODUCTION AND GALLERY

For many years, SCADA system integrators have struggled to eliminate the totalization errors that resulted from using pulse-output flow meters.

With pulse-technology, the most common problem is the inevitable discrepancies between the meter readings displayed within the SCADA system and the readings displayed on the physical meters themselves.

Today, SCADAmetrics has eliminated these errors with the introduction of the EtherMeter® – the telemetry appliance that can ensure absolute agreement between the SCADA system and its connected meters... also known as *revenue-grade accuracy*.

The effectiveness of the EtherMeter is based upon an embrace of the latest AMI (Advanced Metering Infrastructure) technology. Driven by the powerful SCADAmeter® protocol conversion engine, it works by translating totalization and flow rate signals from modern, encoder-based flow meters into industrial protocols that SCADA systems can understand, such as MODBUS, Allen Bradley DF1, and EtherNet/IP.

And for flow-metering applications where encoder technology is not readily available (e.g. chemical, natural gas, petroleum, steam, etc.), the EtherMeter can process most 2-wire pulse signals, as well.

The purpose of this manual is to provide the system integrator with the know-how to set up, install, and maintain the EtherMeter – the new vital component built for today's modern SCADA systems.

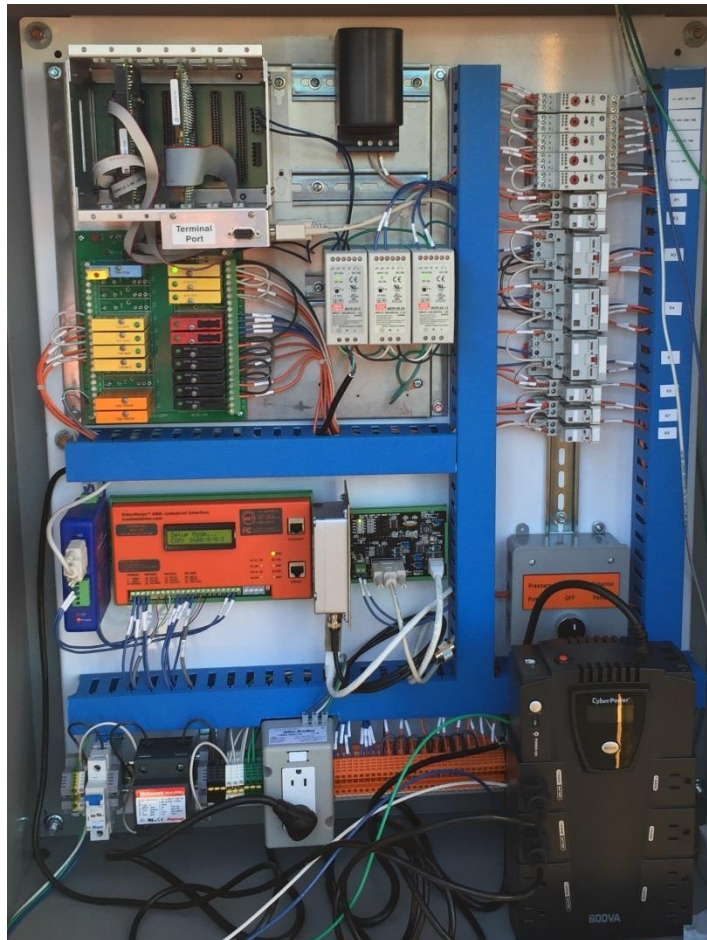

EtherMeter Installed in a Telemetry/SCADA Control Panel at a Water District Pumping Station. Jersey County Rural Water District (Grafton, Illinois). Pump Station by Dakota Pump (Mitchell, South Dakota).



**EtherMeters Installed as part of an Airport Energy/Utility Management System.
JFK International Airport (New York City, NY)**

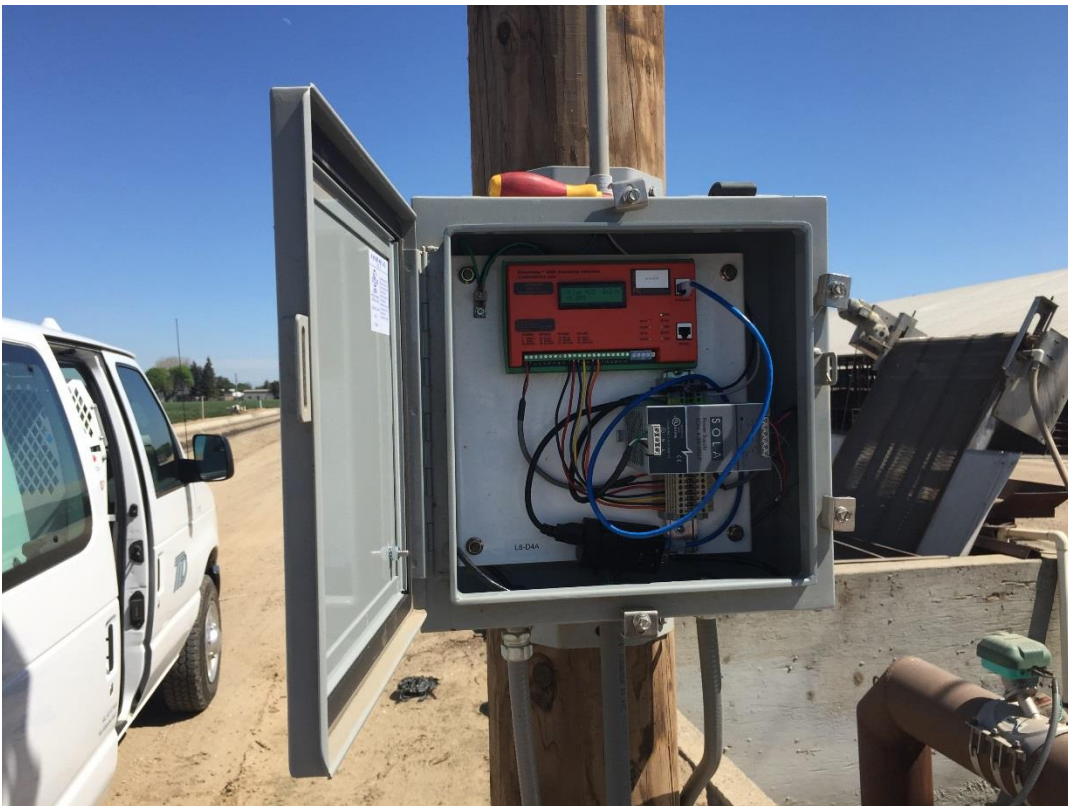

**EtherMeters Installed as part of an Irrigation Monitoring System.
Turlock Irrigation District (Turlock, CA)**



**EtherMeters Installed as part of a Metropolitan Zoo Building Automation System.
St. Louis Metropolitan Zoo (St. Louis, MO)**

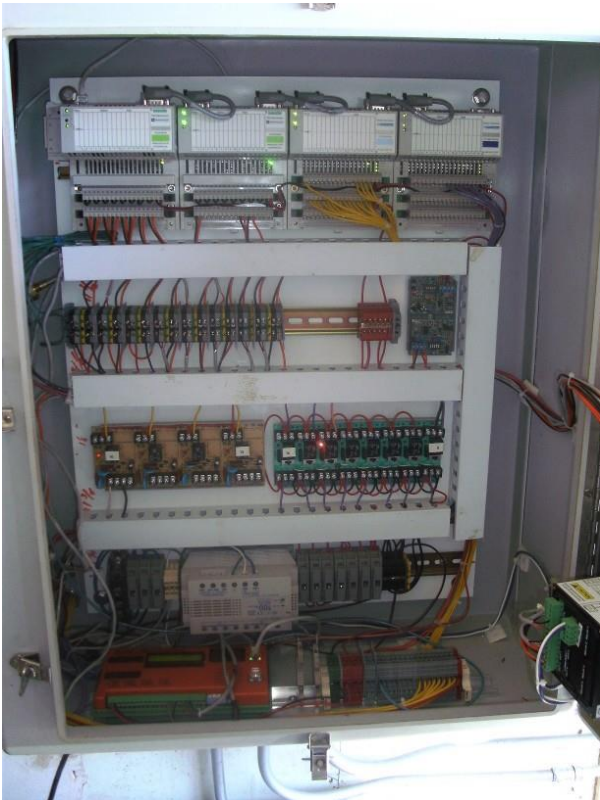

**EtherMeters Installed as part of a US Air Force Base
Utility Management SCADA System.
Davis-Monthan AFB (Tucson, AZ)**



**EtherMeters Installed as part of a Satellite-Based,
Frac Water Automatic Metering System. (Near Williston, ND)**



**EtherMeters Installed as part of a Building Automation System.
AutoDesk Inc. (Boston, MA)**



EtherMeters Installed as part of a University Building Automation System. Illinois Institute of Technology (Chicago, IL)

2 RECOMMENDED SKILLS AND TOOLS

A. SKILLS FOR INSTALLING AND TROUBLESHOOTING AN ETHERMETER:

IT IS RECOMMENDED THAT THE OWNER OR SYSTEM INTEGRATOR READ THIS MANUAL THOROUGHLY BEFORE ATTEMPTING INSTALLATION, SETUP, OR TROUBLESHOOTING.

THE ETHERMETER IS DESIGNED TO BE SET UP AND INSTALLED BY A PROFESSIONAL ELECTRICIAN OR TECHNICIAN WITH EXPERTISE IN THE FIELD OF SCADA, TELEMETRY, INDUSTRIAL AUTOMATION, AND/OR INSTRUMENTATION.

IF THE SETUP TECHNICIAN LACKS THE REQUIRED EXPERTISE, THEN IT IS RECOMMENDED THAT A LOCAL INDUSTRIAL TECHNICIAN BE HIRED FOR THIS PURPOSE. AT A MINIMUM, THE PROFESSIONAL SHOULD BE FAMILIAR WITH THE FOLLOWING CONCEPTS:

1. BASIC WIRING TECHNIQUES
2. GROUNDING
3. AC/DC POWER SUPPLIES
4. SURGE SUPPRESSION AND ISOLATION TECHNIQUES
5. BASIC FLOW METER TOTALIZATION AND FLOW CONCEPTS
6. USER EXPERIENCE WITH TERMINAL EMULATION SOFTWARE (EG HYPERTERMINAL, PUTTY)
7. USER EXPERIENCE WITH TELNET SOFTWARE
8. USER EXPERIENCE WITH WEB-BROWSER SOFTWARE
9. USING AND TROUBLESHOOTING INDUSTRIAL COMM PROTOCOLS (MODBUS, DF1, ETHERNET/IP, AS APPLICABLE)
10. RS-232 SERIAL PORTS, CABLING, AND COMMUNICATIONS
11. RS-485 SERIAL PORTS, CABLING, AND COMMUNICATIONS
12. ETHERNET PORTS, CABLING, ADDRESSING, ROUTING, AND COMMUNICATIONS
13. ANALOG INPUTS (EG. 4-20 MILLIAMPS) (IF APPLICABLE)
14. DIGITAL I/O AND SOLID-STATE RELAYS (IF APPLICABLE)
15. RADIO INTEGRATION (IF APPLICABLE)
16. CELLULAR GATEWAY INTEGRATION (IF APPLICABLE)
17. RTU AND/OR PLC INTEGRATION (IF APPLICABLE)

B. TOOLS FOR INSTALLING AND TROUBLESHOOTING AN ETHERMETER:

1. NOTEBOOK COMPUTER EQUIPPED WITH SERIAL PORT
Caution: Certain USB-Serial Converters do not support all serial port parameters, such as 7E1, 7O1, and 7N2.
Typically, 8N1 is well-supported.
2. EIA-561 TO RS-232C ADAPTER (SCADAMETRICS PART NO. EM-ADAPT-NUL))
3. "HYPERTERMINAL" OR "TERA TERM" TERMINAL EMULATION SOFTWARE (OR EQUIVALENT)
4. ETHERNET PATCH CABLE
5. VOLTMETER / AMMETER
6. TWO (2) SMALL FLAT-HEAD SCREWDRIVERS
7. ONE (1) SMALL #1 PHILIPS SCREWDRIVER

C. TOOLS FOR ATTACHING DIN-RAIL TO A CONTROL PANEL:

1. DIN-RAIL (35MM RECOMMENDED)
2. DIN-RAIL CUTTER (EG. ATMCO LB-100)
3. POWER OR CORDLESS DRILL
4. THREAD-TAPPING TOOL SET
5. MACHINE SCREWS, WASHERS

3 SPECIFICATIONS

A. Meter Communications

Meter Input Channels:	Channel 1: Protocol or Pulse Channel 2: Protocol or Pulse
Galvanic Isolation:	1500V
Protocols:	Sensus Variable-Length: 4 to 9 Digit Sensus Fixed-Length: 4 to 6 Digit Neptune E-Coder Plus: 8 to 9 digit Neptune ProRead Basic: 3 to 6 digit K-Frame (Honeywell-Elster-AMCO, ABB, Kent): 6 Digit Pulse (Dry Contact) Output, 2000 Hz Max.
Protocol Recognition:	Encoder Auto-Detect
Flow Rate Calculation:	dV/dT (Fixed dT or Fixed dV)
Co-Metering Compatibility:	Yes, When Optional SDA or SDAW Duplexer installed.

B. Serial Communications

Ports:	RS-232C (EIA-561 Jack) RS-485 (Phoenix Terminal)
Galvanic Isolation:	2500V
Speed:	300 to 115200 bps
Port Parameters:	8N1, 7E1, 7O1, 7N2
Handshaking:	Fixed RTS, Null Modem, RTS/CTS, CD-Collision Avoidance, None
Industrial Protocols:	MODBUS/RTU, MODBUS/ASCII, DF1/FULL-DUPLEX, DF1/RADIO-MODEM, RAW-ASCII (ASCII-Version Only), ADAM-4000 (ADAM-Version Only) REMOTE VFDisplay (VFDisplay-Version Only)
Setup Terminal:	ANSI, 25x80 char, 9600, 8N1

C. Ethernet Communications

Speed:	10 Mbps (10BaseT), Half or Full Duplex
Galvanic Isolation:	1500Vrms
Addressing:	DHCP or Static IP
Web Server:	Yes
Ping Server:	Yes
Industrial Protocols:	MODBUS/TCP (4 Sockets), EtherNet/IP,PCCC-Encapsulation (4 Sockets), MODBUS/UDP
MAC ID:	IEEE-Assigned OUI: 00-1D-C8

D. Mechanical/Electrical/Environmental

Dimensions:	8.125" x 4.625" x 1.9375"
Weight:	13.5 Ounces
Temperature Range:	-20C to +70C
Relative Humidity:	5% to 95%, Non-Condensing
Panel Mounts:	Two (2) Universal Din-Rail Clips
LCD Display:	2x16 Character, Backlit
Supply Voltage:	10 VDC to 36 VDC
Supply Current:	275 mA Max. (2.50 W Max.) Nominal: 63 mA @ 24 VDC, Nominal: 60 mA @ 24 VDC w/ Backlight OFF
Terminal Block Conductors:	16AWG Max, 26AWG Min.
Internal Power Efficiency:	76%, Typical
Circuit Protection:	Fused (1000mA) + 10 TVSS Diodes
Environmental:	ROHS-Compliant, Lead-free

DIMENSIONAL DRAWINGS

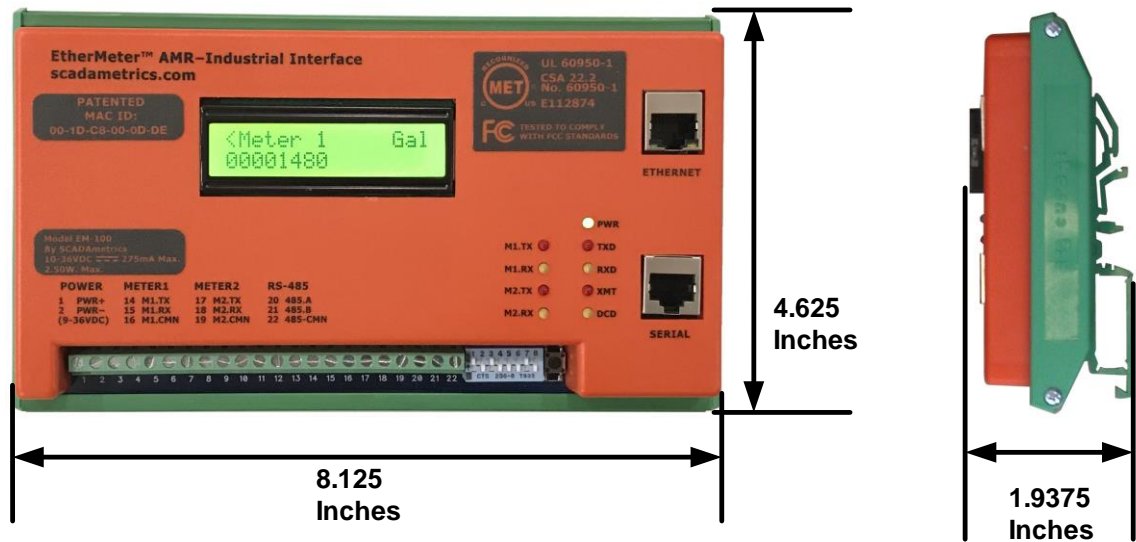

Figure 3A. Dimensional Drawing

E. Auxiliary Inputs/Outputs

Analog Inputs:	Two 4-20mA Inputs (10-bit A/D), 240 Ohm Loop Resistance Configurable as 0-5VDC (10bit A/D)
Integrated Loop Power Supply:	+24VDC / 42mA
Aux Digital I/O:	Three (3): Each Configurable as Digital Input or Output Output(s): TTL (0-5VDC) Output Input(s): TTL Dry-Contact Input
MODBUS Fn. Codes:	01 - Read Coil Status, 02 - Read Input Status, 03 - Read Holding Registers, 04 - Read Input Registers, 05 - Force Single Coil 06 - Write Single Holding Register 15 - Force Multiple Coils
DF1 Codes:	Protected Typed Logical Read With 3 Address Fields Protected Typed Logical Write With 3 Address Fields
ADAM-4000 Fn. Codes: (ADAM-Version Only)	#AA _n - Read Analog Inputs, \$AA6 - Read Discrete Inputs, #AA1n0d - Write Discrete Outputs, \$AAM - Read Device ID

F. Standards and Regulatory Compliances

Safety (USA, Mexico):	UL 60950-1 Recognition (MET Labs File No. E112874)
Safety (Canada):	CSA C22.2 No. 60950-1 Recognition (MET Labs File No. E112874)
Emissions (USA):	FCC Part 15, Class A
Emissions (Canada):	ICES-003
Meter Interface:	AWWA C707-05
Environmental:	ROHS-Compliant, Lead-Free
Manufacturing Location:	USA

G. Safety Considerations and Warnings

The following warnings and guidelines should be followed in order to ensure safe operation of your EtherMeter:

- Do not attempt to service the internal circuitry of the EtherMeter. This device contains no user-serviceable parts or adjustments.
- Carefully inspect the work area in which the EtherMeter will be located to ensure against hazards such as damp floors, ungrounded power extension cords, and missing ground connections.
- Before operating the EtherMeter, ensure that the external power source is an NRTL-listed power supply that is rated for a DC voltage between 10 and 36 VDC and rated for a minimum current of 275 mA. If you are not sure of the type of power source, contact SCADAmetrics or your SCADAmetrics Distributor.
- The secondary output circuits of the EtherMeter are SELV (Safety Extra Low Voltage). Ensure that the secondary output circuits are not connected with hazardous energy levels.
- The EtherMeter has been evaluated and NRTL-recognized for use in a Pollution Degree 2 environment.
- The EtherMeter must be examined for compliance with the applicable safety standard after installation into the final enclosure.
- The EtherMeter must be installed in accordance with all applicable local electrical codes.
- If the EtherMeter is exposed to moisture or condensation, disconnect it from the power source immediately and obtain service assistance.
- If the EtherMeter exhibits unexpected behavior, such as smoking or becoming extremely hot, disconnect it from power sources immediately and then obtain service assistance.
- Ensure that the EtherMeter's cover is secure on completion of installation to reduce safety hazards.

H. Environmental Considerations and Cautions

The following is a list of environmental considerations that will help ensure safe and efficient operation of your EtherMeter:

- Do not position the EtherMeter near high-powered radio transmitters or electrical equipment, such as electrical motors or air conditioners. Interference from electrical equipment can cause intermittent failures.
- Do not install the EtherMeter in areas where condensation, water, or other liquids may be present. These may cause safety hazards and equipment failure.

I. FCC Class A Notice

This device complies with Part 15 of the FCC Rules. Operation is subject to the following two conditions:

1. This device may not cause harmful interference.
2. This device must accept any interference received, including interference that may cause undesired operation.

Note: This equipment has been tested and found to comply with the limits for a Class A digital device, pursuant to Part 15 of the FCC Rules. These limits are designed to provide reasonable protection against harmful interference when the equipment is operated in a commercial environment. This equipment generates, uses, and can radiate radio frequency energy, and if it is not installed and used in accordance with the instruction manual, it may cause harmful interference to radio communications. Operation of this equipment in a residential area is likely to cause harmful interference, in which case the user will be required to correct the interference at his own expense. Modifications: Any modifications made to this device that are not approved by SCADAmetrics may void the authority granted to the user by the FCC to operate this equipment.

Report: <http://scadmetrics.com/PDF/EMC26372-FCC.pdf>

J. ICES Notice (Canada)

This Class [1] digital apparatus complies with Canadian ICES-003.

Report: <http://scadmetrics.com/PDF/EMC26372-IC.pdf>

4 ELECTRICAL INTERFACE

Hookup Wiring Diagram:

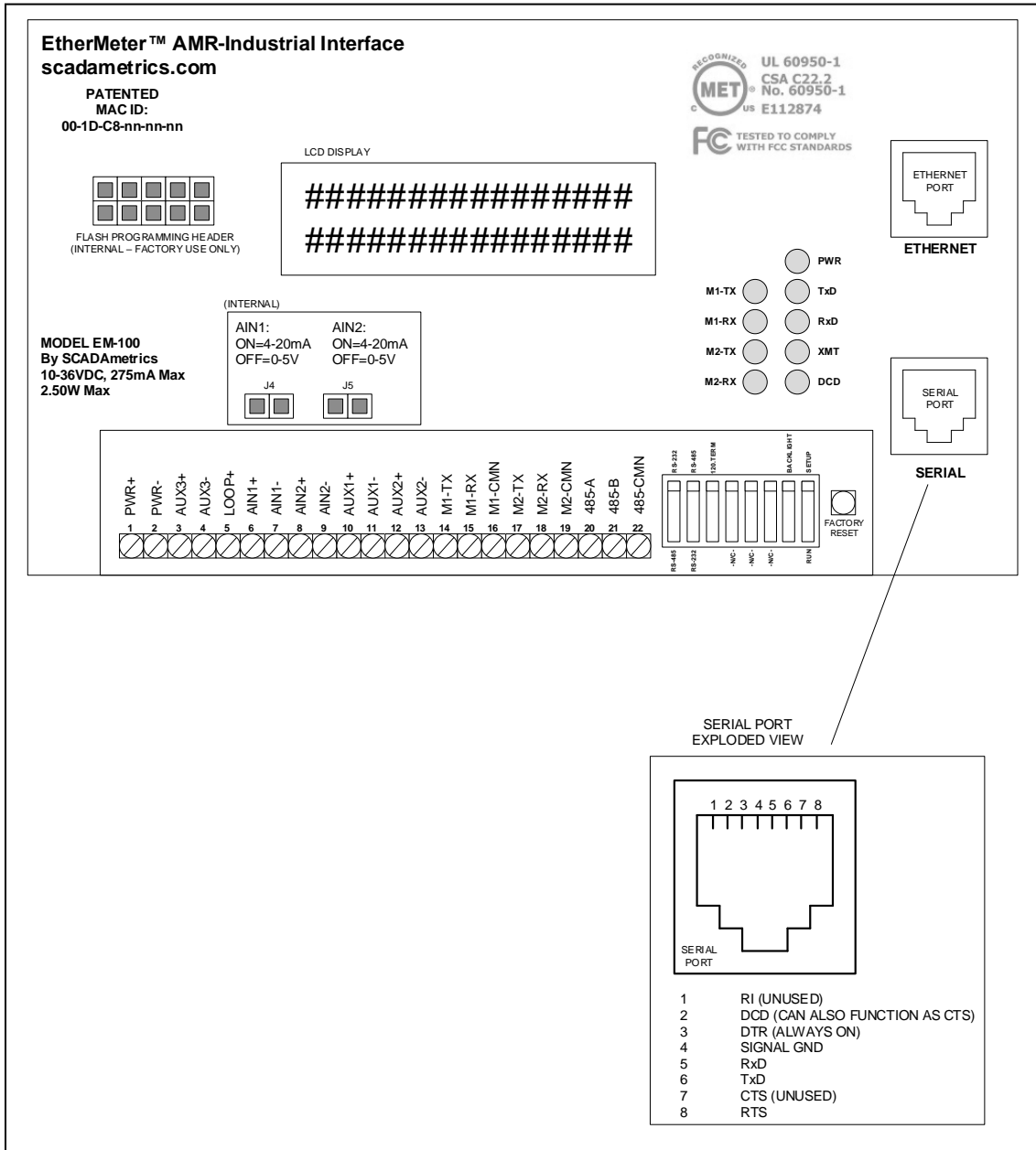

Figure 4A. Electrical Interface

POWER AND ISOLATION NOTES:

1. The EtherMeter requires a 10-36 VDC, Isolated-Output-Type Power Supply. The power consumption of the EtherMeter is 2.50W Max (~1.50W Typical).

DIP SWITCH DEFINITIONS:

#1	#2	#3	#4	#5	#6	#7	#8
UP RS-232C SERIAL PORT ACTIVE (RS-485 SERIAL PORT INACTIVE)	UP RS-485 SERIAL PORT ACTIVE (RS-232C SERIAL PORT INACTIVE)	UP 120 OHM TERMINATION RESISTOR <u>ACTIVE</u> (RS-485 ONLY)	RESERVED -N/C-	RESERVED -N/C-	RESERVED -N/C-	UP BACKLIGHT AND POWER-LED ON	UP SETUP MODE MODBUS/SERIAL DF1/SERIAL INACTIVE
DOWN RS-485 SERIAL PORT IN-ACTIVE RS-232C SERIAL PORT ACTIVE	DOWN RS-232C SERIAL PORT INACTIVE (RS-485 SERIAL PORT ACTIVE)	DOWN 120 OHM TERMINATION RESISTOR <u>INACTIVE</u> (RS-485 ONLY)				DOWN BACKLIGHT AND POWER-LED OFF (POWER SAVING MODE)	DOWN RUN MODE

Figure 4B. DIP Switch Definitions

FACTORY-RESET BUTTON:

The FACTORY RESET Button is located to the right of the dip switches. When the FACTORY RESET button is depressed during a power cycle (or soft reboot), then all user-settings are discarded, and the factory default settings are restored.

5 **METER COMPATIBILITY**

Encoder-Based Flow Meters

The EtherMeter features two flow meter ports, each of which is capable of reading most 3-wire “absolute encoder” registers. In general, encoder registers can be classified as one of the following:

- Sensus Protocol
- Neptune Protocol
- K-Frame Protocol

To maximize ease-of-use, the EtherMeter automatically recognizes the connected meters’ communication protocols, so it’s truly “plug and play”.

Compatible encoder-based flow meters include those produced by ABB, Actaris, Badger, Honeywell-Elster-AMCO-Kent, Hersey, Invensys, Itron, Master-Meter, Metron-Farnier, Neptune, Rockwell, Schlumberger, Sensus, Siemens, Sitrans, and perhaps others.

The complete Meter Compatibility Matrix document is available for download from the Support section of scadameetrics.com. This document details the various meter brands and models that are compatible with the EtherMeter, along with specific configuration details for each meter.

If there is a Sensus-, Neptune-, or K-Frame-protocol encoder meter register that is not listed within the document as compatible based upon testing, and you would like to see it listed as such, then please contact SCADAmetrics. Note that in such cases, we may request a register for testing and verification.

Pulse-Based Flow Meters

The EtherMeter’s flow meter ports are compatible with most pulse-based flow meters. Compatible signals include dry-contact, solid-state contact, and open-collector.

Flow meters that produce active voltage or current pulses are NOT compatible, and would necessarily require conversion to a dry-contact-type signal.

PARALLEL ETHERMETER/AMR HOOKUP FOR SENSUS-COMPATIBLE REGISTERS:

An EtherMeter and a Sensus-Compatible AMI/AMR endpoint may be connected in parallel to a single meter register with the aid of a SCADAmetrics Duplexer (Part No. SDA or SDAW).

A Duplexer may also be used to allow a parallel meter connection of two EtherMeters, also.

Please refer to the **SDA and/or SDAW Documentation** for the most complete and up-to-date application notes and wiring diagrams.

7 NEPTUNE PROTOCOL METER SUPPORT

The Neptune Protocol, as implemented within the E-Coder™, ProCoder™, and ProRead line of registers, is fully supported by the EtherMeter.

Important Notes:

- (1) See the Meter Compatibility Matrix for meter register configuration details.
- (2) Wire color-coding for Neptune-compatibles differs from that used in Sensus-compatibles and K-Frame-compatibles.

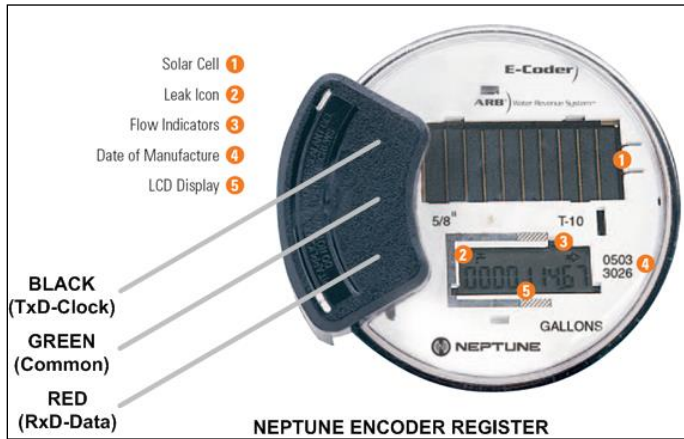

Figure 7A. Neptune E-Coder™ – Register Diagram.

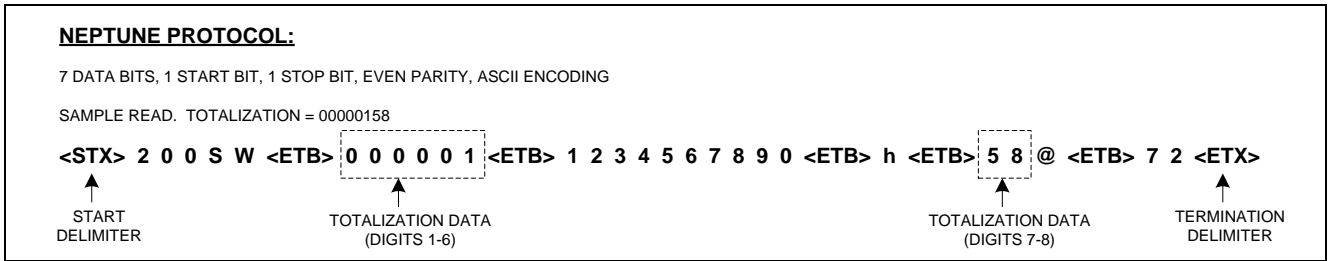

Figure 7B. Neptune – Protocol Diagram Example (Total="00000158").

To connect a Neptune-Protocol Register to Meter Channel 1:

EtherMeter Terminal	Neptune-Compatible Wire Color
14	Black
15	Red
16	Green

To connect a Neptune-Protocol Register to Meter Channel 2:

EtherMeter Terminal	Neptune-Compatible Wire Color
17	Black
18	Red
19	Green

METER HOOKUP FOR NEPTUNE-COMPATIBLE REGISTERS:

The following diagram demonstrates the hookup of a Neptune-compatible encoder register to Meter Channel 1 of the EtherMeter. Terminals 14, 15, and 16 are used in this case. Hookup to Meter Channel 2 will be identical, except terminals 17, 18, and 19 are used.

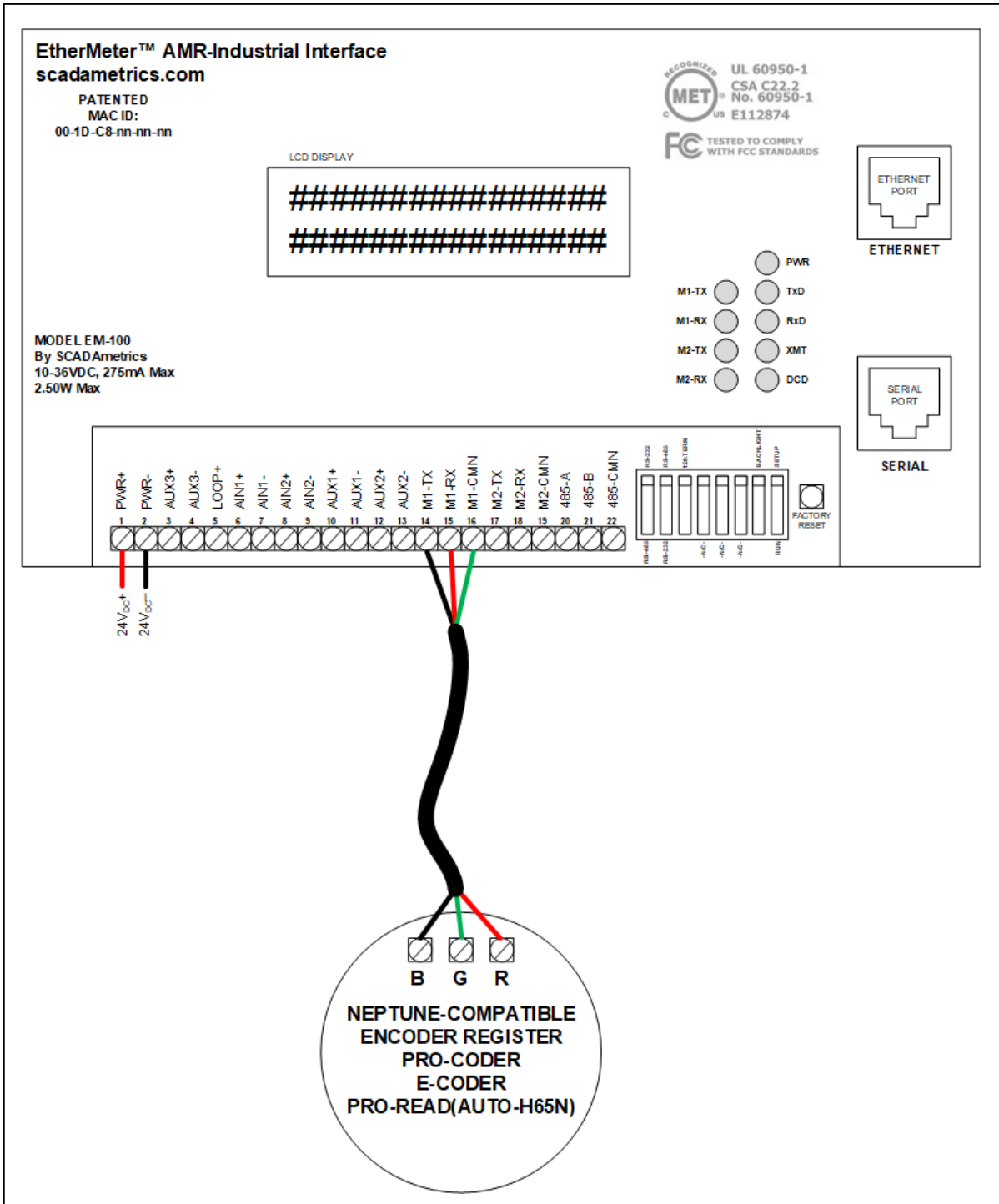

Figure 7C. Neptune Register Hookup to EtherMeter

PARALLEL ETHERMETER/AMR HOOKUP FOR NEPTUNE-COMPATIBLE REGISTERS:

An EtherMeter and a Neptune-Compatible AMI/AMR endpoint may be connected in parallel to a single meter register with the aid of a SCADAmetrics Duplexer (Part No. SDA or SDAW).

A Duplexer may also be used to allow a parallel meter connection of two EtherMeters, also.

Please refer to the **SDA and/or SDAW Documentation** for the most complete and up-to-date application notes and wiring diagrams.

8 K-FRAME (ELSTER) PROTOCOL METER SUPPORT

K-Frame Protocol support applies to certain meters manufactured by Honeywell-Elster-AMCO-Kent-ABB. Compatible registers include the evoQ4 (Honeywell-Elster), InVISION (Honeywell-Elster-AMCO), ScanCoder (Elster-AMCO, ABB, Kent), and the AquaMaster mag-meter (ABB).

Important Notes:

(1) The instructions in this chapter do not apply to Sensus-protocol registers that are manufactured by Honeywell-Elster-AMCO (See Ch. 6, Sensus Protocol Meter Support).

(2) See the Meter Compatibility Matrix for meter register configuration details.

(3) Wire color-coding for K-Frame-compatibles differs from that used in Sensus-compatibles and Neptune compatibles.

(4) The EtherMeter will **automatically** configure the registration units (UNITn) and multiplier (EXPn) for Elster K-Frame protocol meters, as this information is embedded within the protocol.



Figure 8A. Honeywell-Elster-AMCO InVISION – Register Diagram.

To connect a K-Frame Protocol Register to Meter Channel 1:

EtherMeter Terminal	K-Frame Compatible Wire Color* *Note: Color codes may vary by meter brand. See Meter Compatibility Matrix for details.
14	Green
15	Red
16	Black

To connect a K-Frame Protocol Register to Meter Channel 2:

EtherMeter Terminal	K-Frame Compatible Wire Color* *Note: Color codes may vary by meter brand. See Meter Compatibility Matrix for details.
17	Green
18	Red
19	Black

PARALLEL ETHERMETER/AMR HOOKUP FOR K-FRAME COMPATIBLE REGISTERS:

An EtherMeter and a K-Frame-Compatible AMI/AMR endpoint may be connected in parallel to a single meter register with the aid of a SCADAmetrics Duplexer (Part No. SDA or SDAW).

A Duplexer may also be used to allow a parallel meter connection of two EtherMeters, also.

Please refer to the **SDA and/or SDAW Documentation** for the most complete and up-to-date application notes and wiring diagrams.

9 PULSE METER SUPPORT

The EtherMeter provides meter-reading support for pulse-based meters. As a consequence, pulse meter signal(s) may be connected to either (or both) of the EtherMeter's meter input channels.

Pulse processing technology allows the EtherMeter to collect meter totalization and flow rate data from non-encoder-based meters. Common examples include petroleum & chemical meters, commercial & industrial natural gas meters, volume correctors, and many others.



When the EtherMeter handles pulse-based meters, the totalization and flow-rate data is stored and transmitted from the same Modbus- and Rockwell-compatible memory registers that it uses for encoder-based meters. Therefore, regardless of which type of meter(s) is connected to the EtherMeter (encoder versus pulse), collection of totalization and flow data by the connected SCADA system is identical.

Supported Pulse Input Types:

- Mechanical Dry Contact
- Solid-State Dry Contact
- Open-Collector Input

PULSE-BASED METERS SAMPLE CIRCUIT DIAGRAM

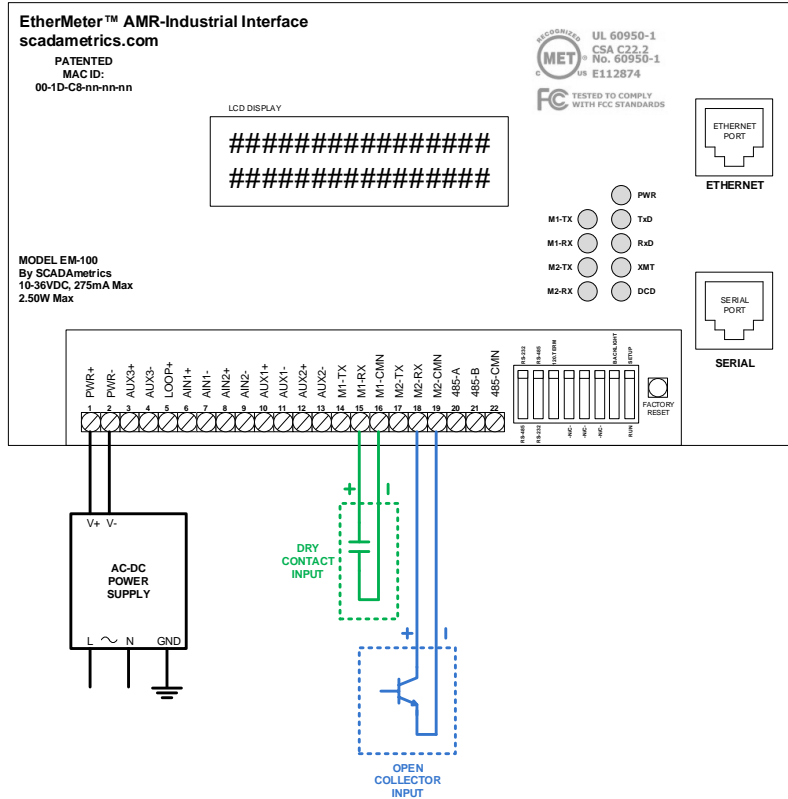

Figure 9A. Example Pulse Signal Hookups to EtherMeter

Setup Via Serial Terminal or Telnnet:

When a pulse-based meter input is desired, the user should set the TYPEn parameter to PULSE. In the example below, the user has set Meter Channel 2 as a pulse-based meter. After TYPEn is set to PULSE, note that additional user-options become visible on Pg.1 of the Setup Screen. DBn is a firmware debounce filter setting (see section below), and CNTn is used to synchronize the EtherMeter’s totalization with that on the meter register (index). PSn (Pulse Scaler) and PDn (Pulse Divider) are parameters used to scale the pulse count into engineering units. For example, if meter 1 emits 1431 pulses per 1000 gallons, then PD1 should be set to 1431 and PS1 should be set to 1000.

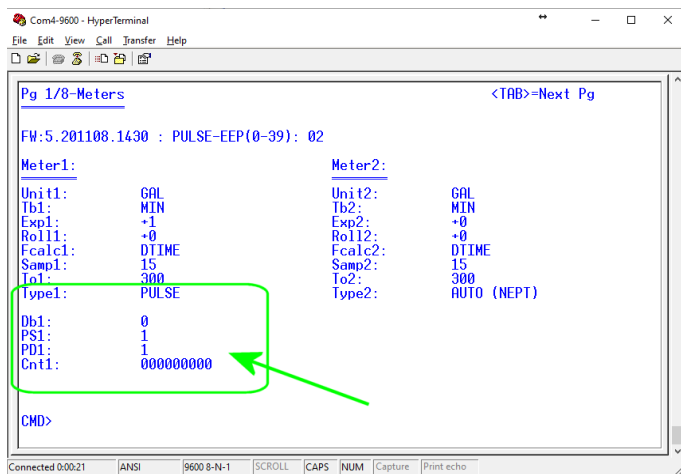

Figure 9B. Serial Terminal / Telnnet Pulse Setup Screen

Debounce Filter:

In order to mitigate the adverse effects of contact bounce, user-adjustable de-bounce logic has been implemented within the EtherMeter firmware.

The user may adjust the DBn parameter to increase or decrease the pulse sensitivity. DBn refers to the minimum required quiet time enforced after the leading edge of a valid pulse has been detected. DBn can be set to any value between 0 and 10000 milliseconds. When DBn is set to ZERO, the debounce filter is disabled (factory default).

As an example, if DBn is set to 60, then any pulses which arrive before T_0 has expired will be ignored.

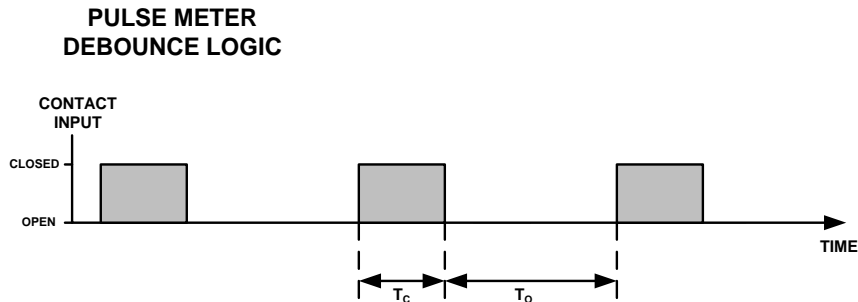

Figure 9C. Pulse Meter Debounce Logic Illustration

Batching Operations:

- CNT1 can be reset to ZERO by writing a '1' to Modbus Coil 9, or by writing a '1' to Allen Bradley-compatible register B10:0/8.
- CNT2 can be reset to ZERO by writing a '1' to Modbus Coil 10, or by writing a '1' to Allen Bradley-compatible register B10:0/9.

Pulse Meter Notes:

- Maximum pulse frequency: 2000 Hz (2000 Pulses Per Second).
- Active Voltage and Current Pulses are not supported.
- Each of the EtherMeter's pulse-input channels contain an integral +5 VDC power supply and a 900 Ohm pull-up resistor. Therefore, an external voltage source and pull-up resistor circuit is not required.
- The EtherMeter sources a maximum 0.5 milliamp through the contact circuit.
- Totalization and Flow-Rate Calculations (UNITn, TBn, ROLLn, FCALCn, SAMPn, TOn parameters) are handled identically for pulse-type meters as for encoder-type meters.
- Factor-of-10 scaling (EXPn parameter) is handled identically for pulse-type meters and encoder-type meters.
- The pulse count(s) are stored to nonvolatile EEPROM every 8 minutes. Therefore, if the power to the unit is cycled, then the loss of up to 8 minutes of pulses is possible. To reduce the likelihood of lost pulses due to power outages, a battery backup power supply is recommended.
- When the user toggles DIP SWITCH 8 (SETUP/RUN Mode), then the current pulse count(s) are immediately stored to EEPROM.

10 PLC/RTU/COMPUTER INTERFACE

There are currently three (3) physical types of signal connections that can be made between a PLC/RTU/Computer and the EtherMeter.

- RS-232C Serial
- RS-485 Serial
- Ethernet

CAUTION:

The EtherMeter utilizes an RJ-45 jack for the RS-232C serial port **AND** another RJ-45 jack for the Ethernet port. The device was intentionally designed in this manner so as to reduce the number of cable types required by the SCADA Integrator. However, it is imperative that the serial port not be mistaken for the Ethernet port, and vice versa.

The serial port is designated with the marking "SERIAL" directly beneath it, and the Ethernet port is designated with the marking "ETHERNET" directly beneath it.

Plugging a serial device into the Ethernet port and/or plugging an Ethernet device into the serial port may cause irreversible damage to the EtherMeter and/or the connecting equipment. Please proceed with due care and caution when hooking up to the ports.





RS-232C Serial Port

The RS-232C serial port is implemented within a RJ-45 modular jack and conforms to the EIA-561 standard. The pinout is as described in Section 4.

In order to activate the RS-232C serial port, the 1st dip switch should be placed in the "up" position, and the 2nd dip switch should be placed in the "down" position. Note that either the RS-232C or RS-485 serial port can be activated, but not both simultaneously.

It is important to note that the RS-232C serial port is optically-isolated to a rating of 2500V.

When connecting a PLC/RTU/PC/RADIO to the RS-232C serial port of the EtherMeter, the modular adapters manufactured by QVS are highly recommended:

QVS Modular Jack Utility Matrix		
Function	QVS Part#	Photo
RJ-45 to DB9F	CC-439	
RJ-45 to DB9M	CC-438	
RJ-45 to DB25F	CC-343	
RJ-45 to DB25M	CC-342	

Note the following QVS color codes as mapped to the RS-232C (EIA-561) Jack:

QVS ADAPTOR WIRE COLOR	FUNCTION	IMPLEMENTED IN THE ETHERMETER?
BLUE	RING INDICATOR	NO
ORANGE	DCD (OR CTS)	YES
BLACK	DTR	YES (TIED TO V+)
RED	SIG GND	YES
GREEN	RxD (DATA RECEIVED BY ETHERMETER)	YES
YELLOW	TxD (DATA TRANSMITTED BY ETHERMETER)	YES
BROWN	CTS	NO (BUT SEE DCD (ORANGE) ABOVE)
WHITE	RTS	YES

RS-485 Serial Port

The RS-485 serial port is implemented within three (3) Phoenix Contact screw terminals. The pinout is as described in Section 4.

In order to activate the RS-485 serial port, the 1st dip switch should be placed in the “down” position, and the 2nd dip switch should be placed in the “up” position. Note that either the RS-232C or RS-485 serial port can be activated, but not both simultaneously.

When the EtherMeter is staged at the endpoint of the transmission line, a 120 Ohm termination resistor should be used. For convenience, a 120 Ohm, ½ Watt resistor is included as a feature within the device. To activate the termination resistor, the 3rd dip switch should be placed in the “up” position. In all other cases, this resistor should be disabled with the dip switch in the “down” position.

A DC common reference terminal is included with the RS-485 port (terminal 22). This terminal is connected to the device’s DC common through a 120 Ohm, ½ Watt current-limiting resistor. It is important to note that the RS-485 serial port is optically-isolated to a rating of 2500V.

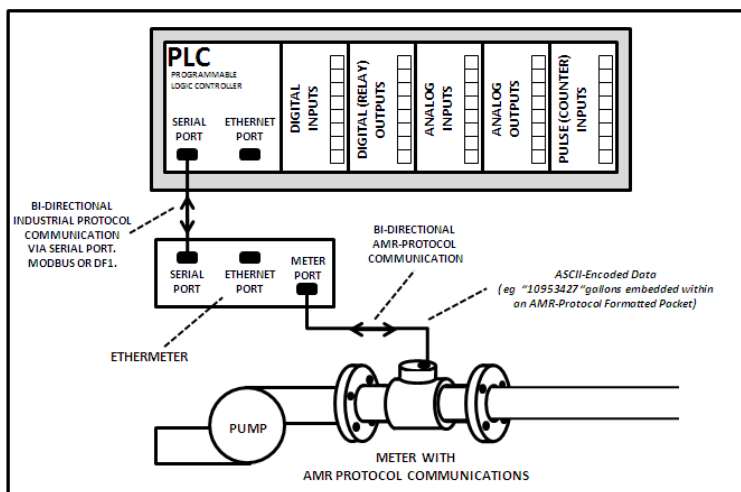

Figure 10A. An example of an EtherMeter connected to the serial port of a PLC.

Ethernet Port

The Ethernet port is a 10BaseT modular jack, and operates at a maximum data rate of 10 Mbps. Both dynamic (DHCP) and static IP addressing are supported.

The Ethernet port supports the ARP ping function, serves a web page on TCP port 80, and provides a Telnet Server for remote configuration and troubleshooting.

MODBUS/TCP (4 sockets) is active at all times on TCP port 502, and MODBUS/UDP is active at all times on UDP port 502. MODBUS/RTU (Piped over UDP) is active at all times on UDP port 503.

EtherNet/IP (4 sockets) is active at all times on TCP port 44818.

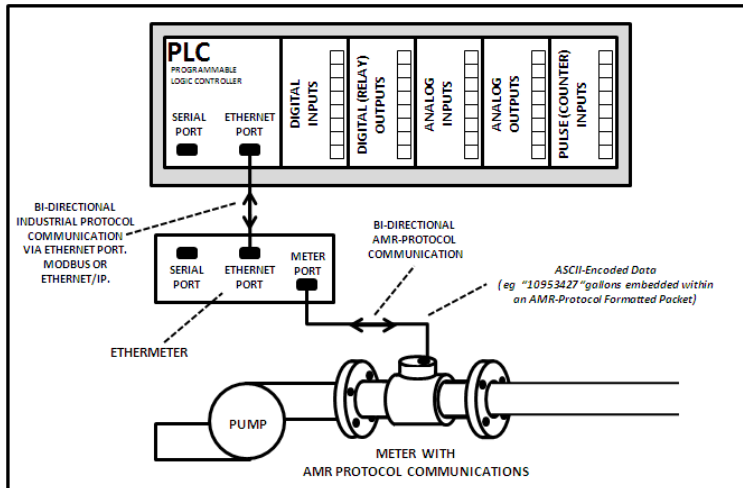

Figure 10B. An example of an EtherMeter connected to the Ethernet port of a PLC.

11 RADIO INTERFACE

Support is provided for direct connection to most popular industrial radio modems. Depending upon the radio, the connection may be made via the RS-232C or RS-485 serial port, or via the Ethernet port. Serial Port parameters may be tailored for the radio via the Settings Menu. The following list is far from exhaustive, but serves to enumerate some of the most popular, compatible industrial radio modems.

Ritron	DTX+, DTXM, DTXLS
SCADAmetrics	Bell 202 Modem for Analog Telemetry Radios
Microwave Data Systems	TransNet, entraNet, iNet, 1710, 2710, 4710, 4790, 9710, 9790
Maxon/Tecnet	SD-Series, TD-Series
Sierra Wireless	Cellular Gateways
Iridium / Joubeh Technologies	9602W SBD Satellite Modem
Maxstream	XTend-PKG 900 MHz, RS-232, Industrial or Commercial
Zlinx	ZP9D, ZP24D Series
Cirronet	HopNet Serial and Ethernet Series
Calamp/Dataradio	DL-3400, Integra-IP, Integra-TR, Integra-H, T96-SR, TSLM, JSLM, VIPR, HIPR
Calamp	819, 822, 882 Cellular Data Modems

Solar Energy-Saver Features:

The EtherMeter supports an energy-saver feature that may be useful in solar-powered applications. When the Dout1 setting is PwrSavLo or PwrSavHi, the 1st auxiliary digital output may be interfaced to a solid-state relay to power down a radio between polling sessions. The operation is described through the following example:

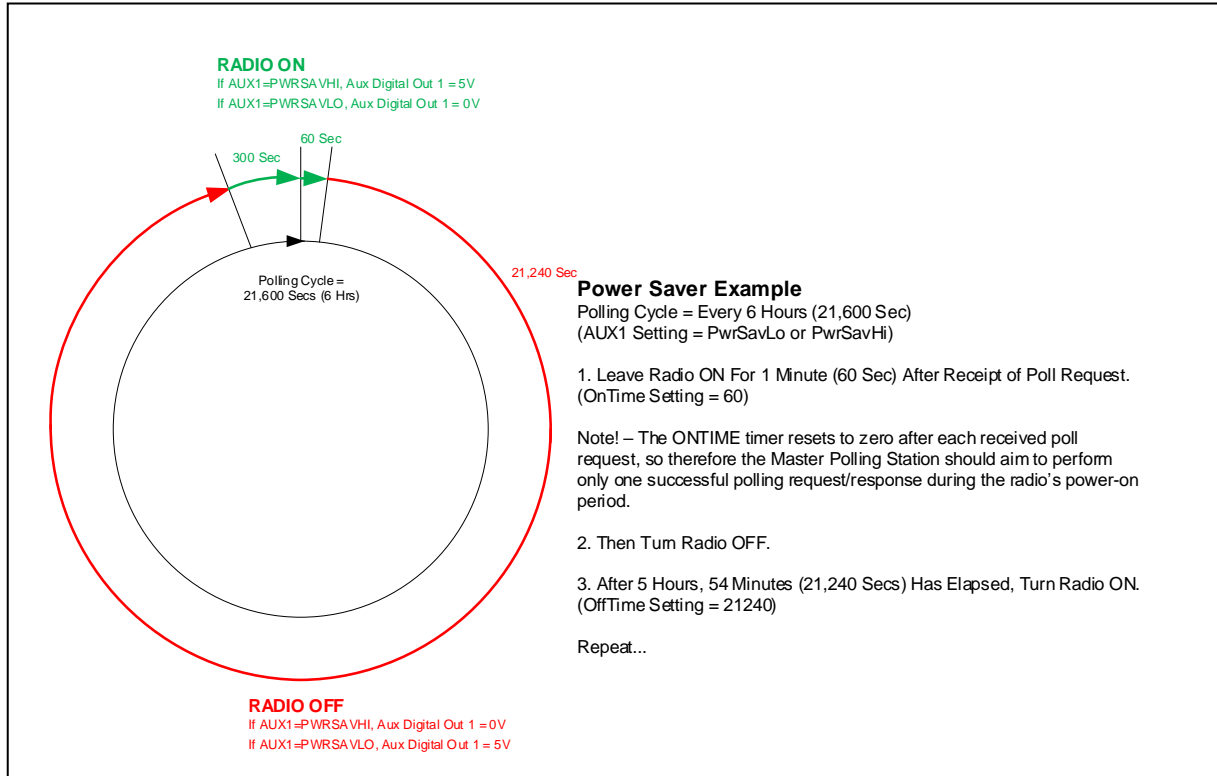



Figure 11A. Power Saver Illustration

12 AUXILIARY I/O CHANNELS

As an added benefit, the EtherMeter is equipped with five (5) auxiliary inputs and outputs: Two (2) analog inputs, and three (3) digital I/O. The auxiliary I/O make the device suitable for deployment as a standalone RTU at low-complexity locations, such as master meter vaults or even simple pumping stations.

Auxiliary I/O Type	Notes
Digital Input(s) (0,1,2, or 3)	Dry Contact Only. Closed = ON (1) Open = OFF (0) Shared DC Common with Meter IO, Analog IO, and LOOP+.
Digital Output(s) (0,1,2 or 3)	0-5V TTL Requires an external NRTL-Listed or Recognized Solid-State Relay. eg. Power-IO P/N IO-ODC-60 for DC loads, or Power-IO P/N IO-OAC-280 for AC loads.  Digital Output #1 can be used for radio power-saver output. Shared DC Common with Meter IO, Analog IO, and LOOP+.
Analog Input 1	4-20mA (default) or 0-5VDC. 0-5VDC is activated by removing JP1 (inside case). 4-20mA loop resistance = 240 Ohms. Shared DC Common with Meter IO, Digital IO, and LOOP+. Caution: AIN1+ should NEVER be connected to a voltage greater than 5VDC above the Shared DC common. (See Recommended Wiring Diagram later in this section.) Unless the external analog device is powered by LOOP+, an external analog-to-analog isolation module should be used! (eg. Dataforth Sensorlex® 8B series or DSCA series modules.) 

Analogue
Input 2

4-20mA (default) or 0-5VDC.
0-5VDC is activated by removing JP1 (inside case).
4-20mA loop resistance = 240 Ohms.
Shared DC Common with Meter IO, Digital IO, and LOOP+.
Caution: AIN2+ should NEVER be connected to a voltage greater than 5VDC above the Shared DC common.
(See Recommended Wiring Diagram later in this section.)

Unless the external analog device is powered by LOOP+, an external analog-to-analog isolation module should be used! (eg. Dataforth Sensorlex® 8B series or DSCA series modules.)



CORRECT 4-20mA ANALOG INPUT WIRING:
 (NOTE THAT THE TRANSDUCER POSITIVE IS CORRECTLY CONNECTED TO LOOP+)

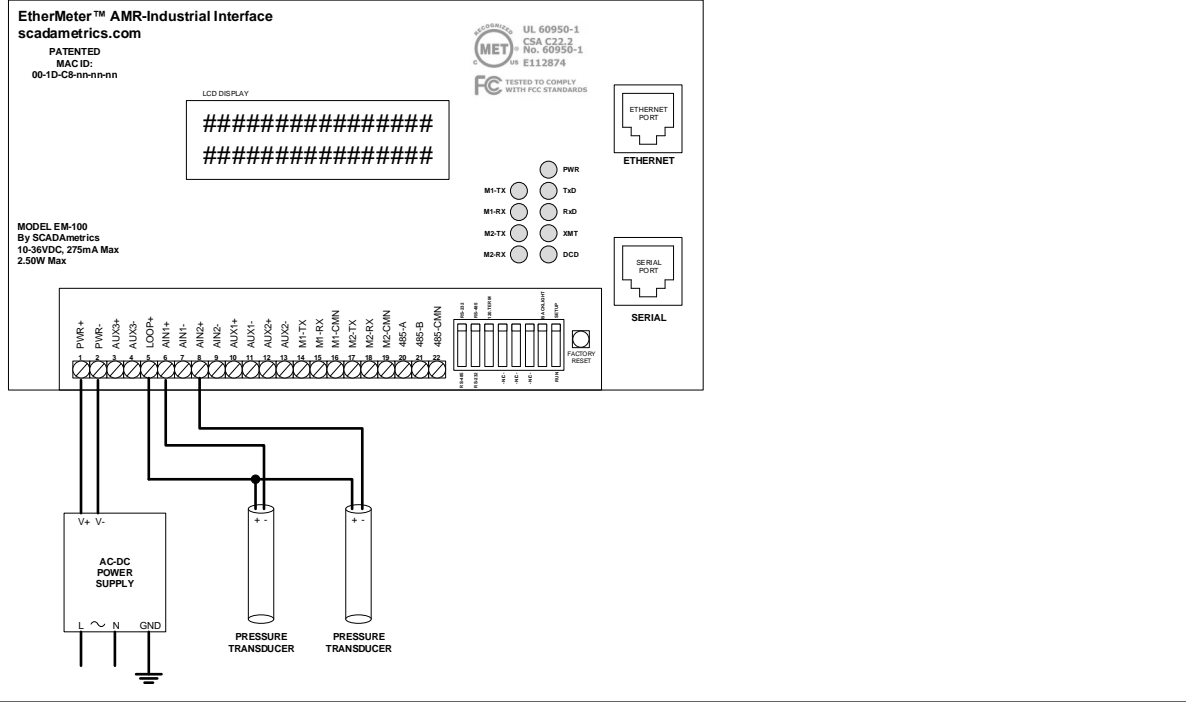

Figure 12A. Correct 4-20mA Analog Input Wiring.

CORRECT 0-5V ANALOG INPUT WIRING:
 (NOTE THAT THE TRANSDUCER SUPPLY VOLTAGE IS CORRECTLY CONNECTED TO LOOP+)

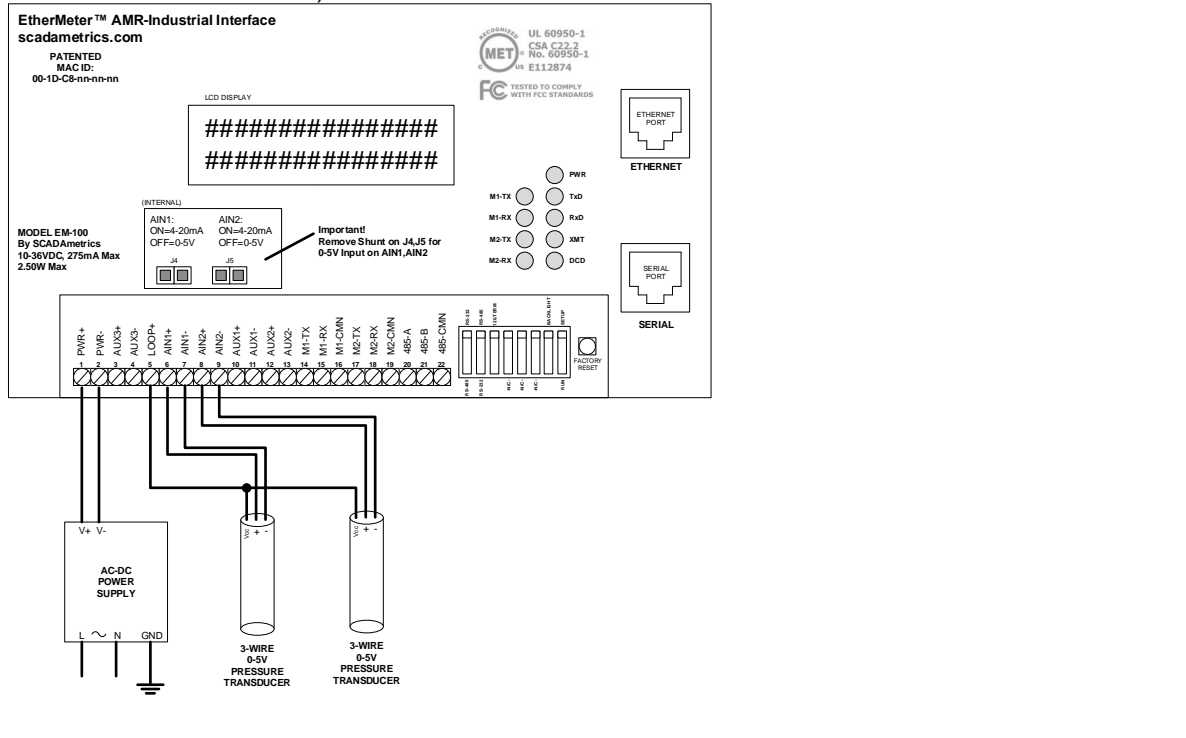

Figure 12B. Correct 0-5V Analog Input Wiring.

The following diagram is an example of an EtherMeter deployed as a standalone RTU. Note the use of the auxiliary I/O to provide ON/OFF signaling and analog input monitoring, in addition to monitoring one (or two) meter registers.

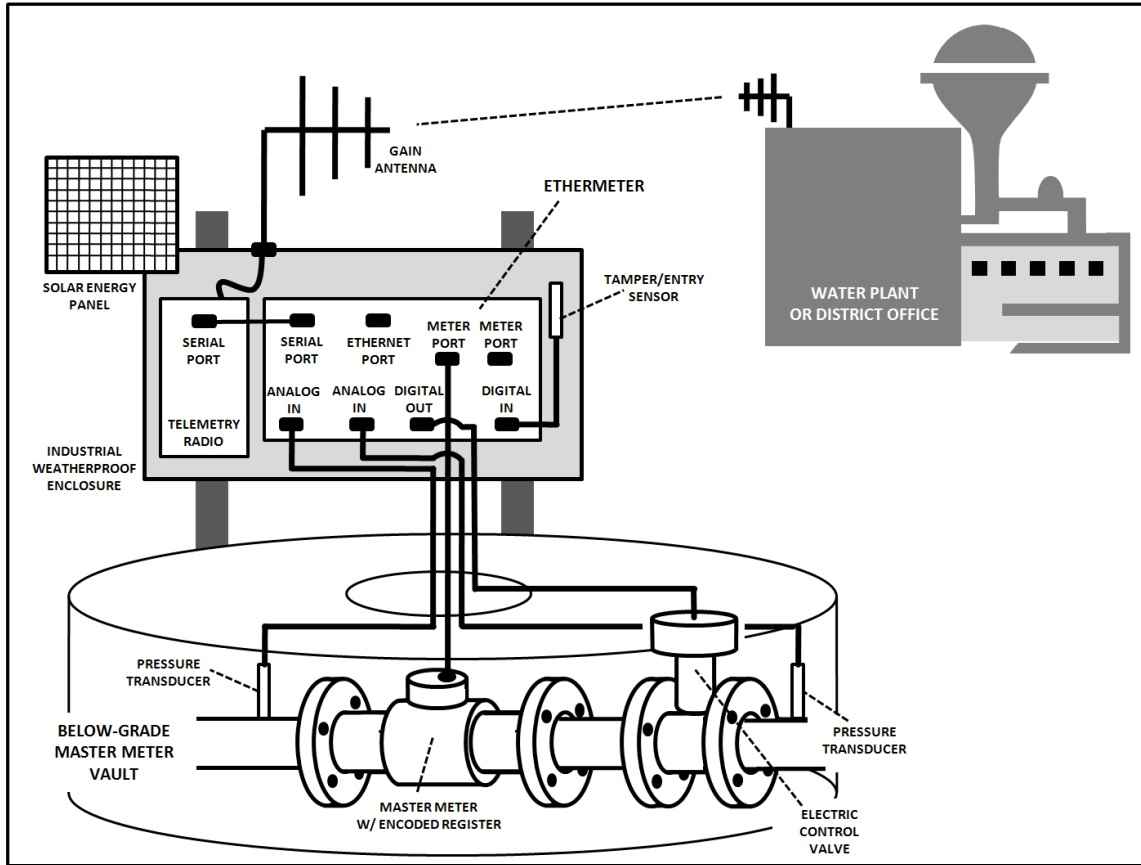

Figure 12C. Example Standalone EtherMeter as RTU or Remote I/O

13 SETUP AND DIAGNOSTIC UTILITIES

In order to set up the EtherMeter, the technician should actuate the #8 dip switch to the “up” position. At this point, industrial protocols are disabled on the active serial port (RS-232 or RS-485, depending upon dip switches #1 and #2). In setup mode, the EtherMeter’s serial port operates with the following parameters:

- **9600 bps Baud Rate**
- **8 Data Bits**
- **1 Start Bit**
- **1 Stop Bit**
- **No Parity**
- **No Flow Control**
- **ANSI Terminal Emulation**

The technician should start the HyperTerminal program and select your PC’s appropriate serial COM port (eg COM1... COM12, etc.). Note that HyperTerminal should be configured to operate with settings that match the EtherMeter (as shown in the bulleted list above). The HyperTerminal session parameters may be saved through its “File>Save” or “File>Save As” menu, thereby allowing the user to skip the HyperTerminal configuration menus during future sessions.

After HyperTerminal is configured, the user should click on HyperTerminal’s “Connect” button (or use the menu: “Connect>Connect”). Once connected, the user should press the <ENTER> key on the keyboard, which will wake up the EtherMeter’s Setup Program. Note that, from any setup screen, <ENTER> causes a refresh, and <TAB> causes the display to proceed to the next screen. There are eight (8) setup screens in total.

For reference, the eight (8) Setup Menu screens are shown below:

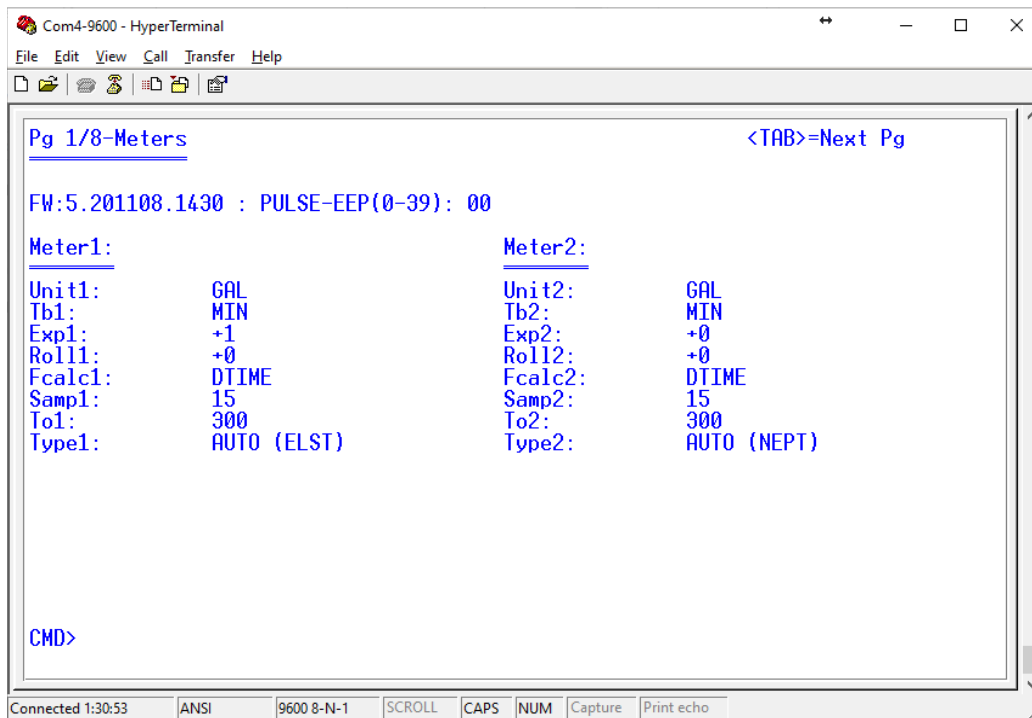

**Setup Screen #1 of 8
“Meter Setup”**

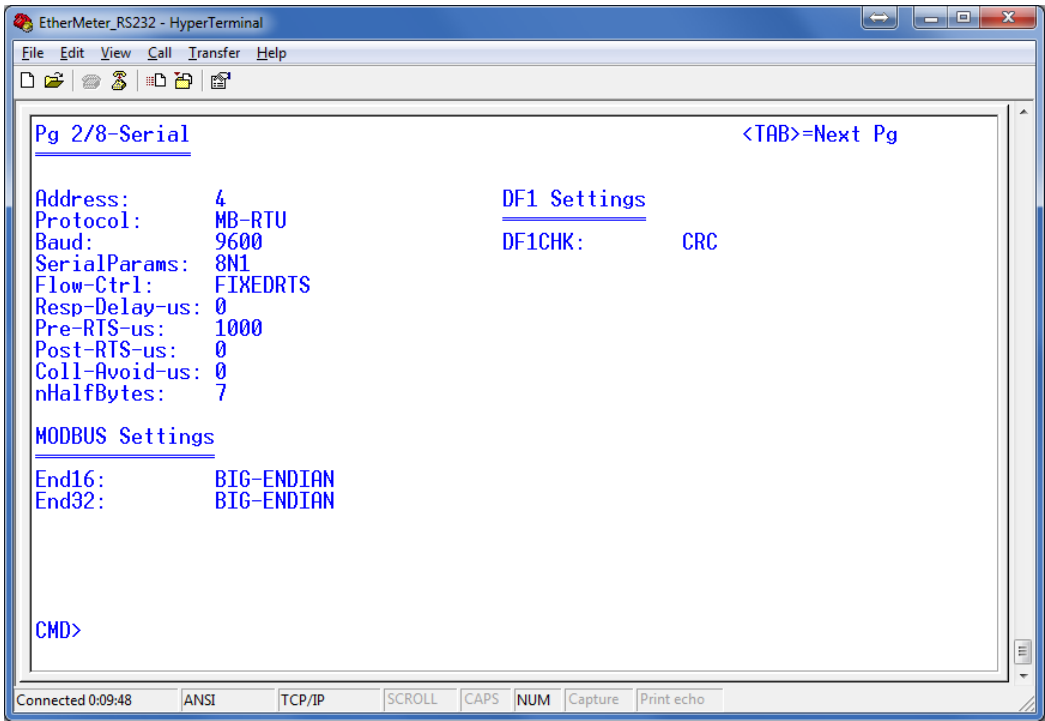

Setup Screen #2 of 8
"Serial Port Setup"

Setup Screen #3 of 8
"Networking Setup"

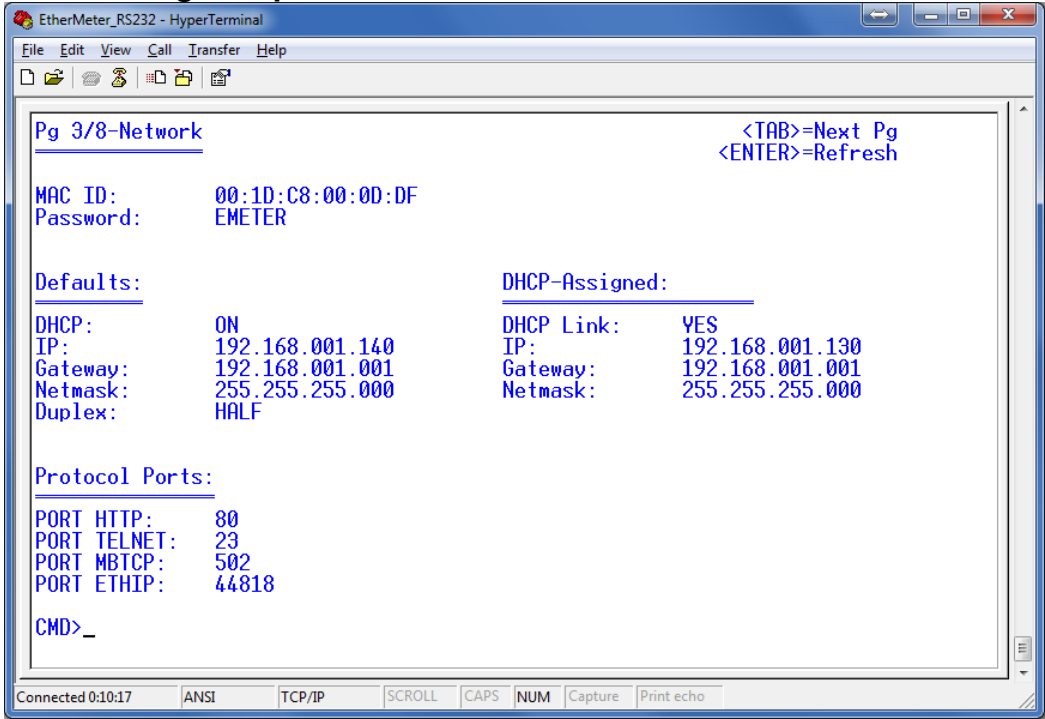

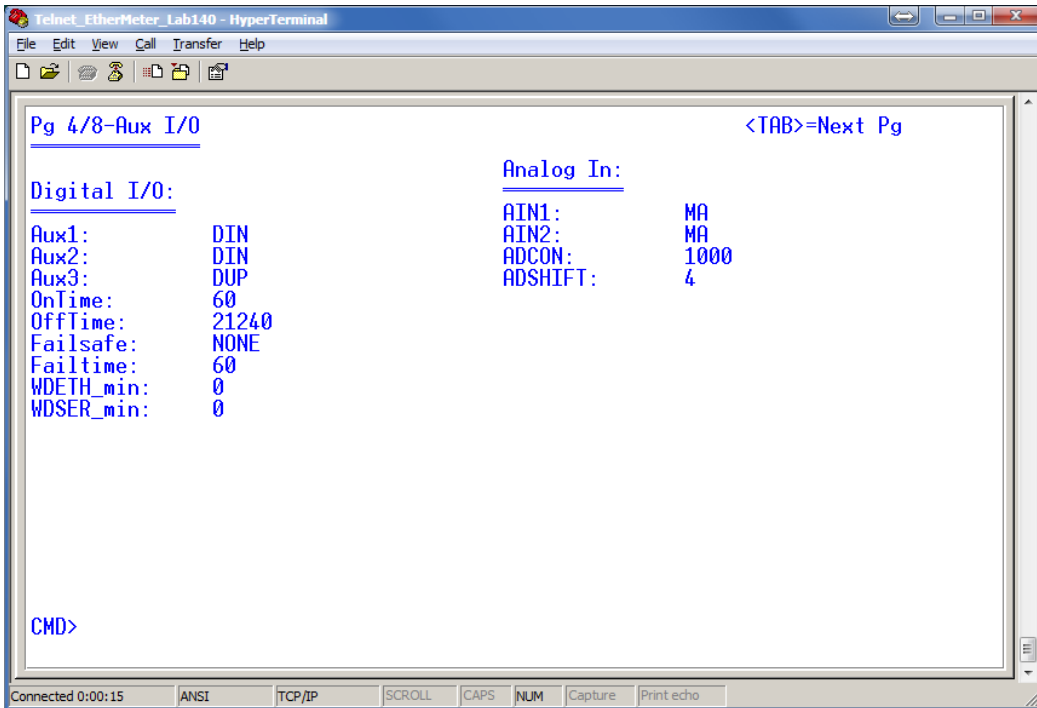

**Setup Screen #4 of 8
“Auxiliary I/O Setup”**

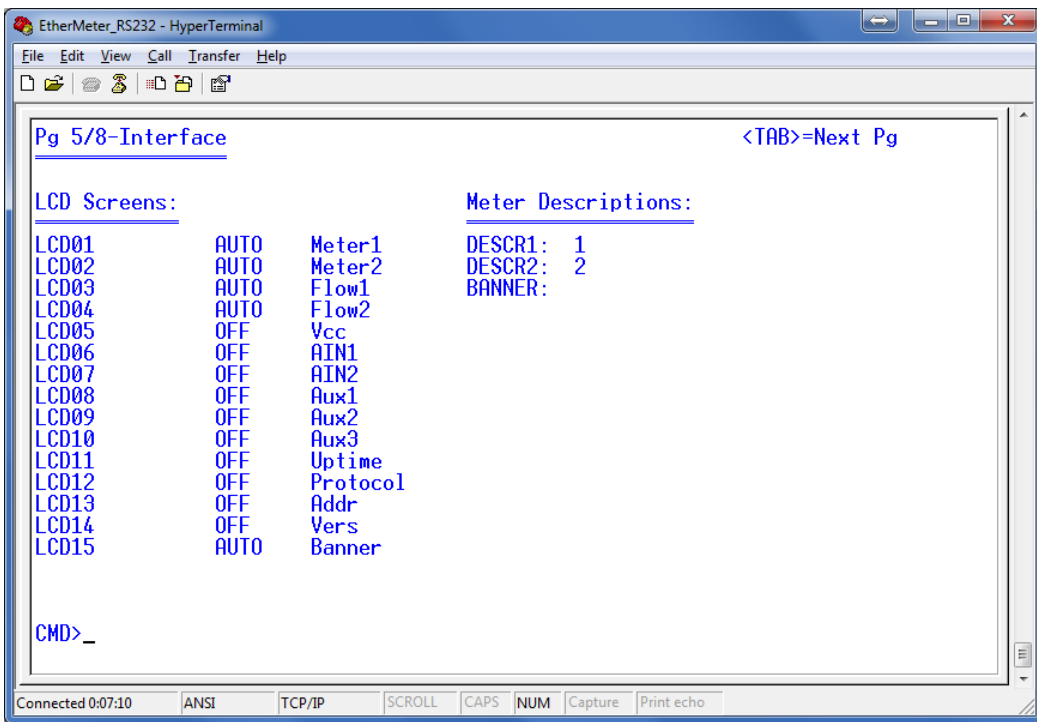

**Setup Screen #5 of 8
“Interface Setup”**

```

EtherMeter_RS232 - HyperTerminal
File Edit View Call Transfer Help
Pg 6/8-Reg Displ 1 <TAB>=Next Pg
-<MODBUS REG>-----<AB REG>-----
40001-02 N7:0-1 Meter1(Unscaled) : 444
40003-04 N7:2-3 Meter2(Unscaled) : 45198
40005-06 N7:4-5 Flow1x1K : +0
40007-08 N7:6-7 Flow2x1K : +0
40009 N7:8 Rollovers1 : +0
40010 N7:9 Rollovers2 : +0
40011 N7:10 AIN1(0-10K) : 10008
40012 N7:11 AIN2(0-10K) : 10008
40013 N7:12 VCCx10 : 241
40014 N7:13 StatusBits : 0x0000
40015 N7:14 Meter1-Fault : 0
40016 N7:15 Meter2-Fault : 0
40017-18 N7:16-17 Uptime(min) : 9
40019 N7:18 M1-nDig : 8
40020 N7:19 M2-nDig : 8
40021 N7:20 M1-Expon : +0
40022 N7:21 M2-Expon : +0
40023 N7:22 M1-Units : 0
40024 N7:23 M2-Units : 0
40025 N7:24 M1-FaultCnt : 0
40026 N7:25 M2-FaultCnt : 0_

Connected 0:08:18 ANSI TCP/IP SCROLL CAPS NUM Capture Print echo

```

Setup Screen #6 of 8
“MODBUS/DF1 Register Realtime Display 1 of 2”

```

EtherMeter_RS232 - HyperTerminal
File Edit View Call Transfer Help
Pg 7/8-Reg Displ 2 <TAB>=Next Pg
-<MODBUS REG>-----<AB REG>-----
10001 B250:0/0 AuxDigIO 1 : 0
10002 B250:0/1 AuxDigIO 2 : 0
10003 B250:0/2 AuxDigIO 3 : 0
10004 B250:0/3 : 0
10005 B250:0/4 : 0
10006 B250:0/5 : 0
10007 B250:0/6 : 0
10008 B250:0/7 : 0
10009 B250:0/8 Meter1 ReadFail : 0
10010 B250:0/9 Meter2 ReadFail : 0
10011 B250:0/10 Meter1 FwdFlow Y/N : 0
10012 B250:0/11 Meter2 FwdFlow Y/N : 0
10013 B250:0/12 Meter1 RevFlow Y/N : 0
10014 B250:0/13 Meter2 RevFlow Y/N : 0
10015 B250:0/14 : 0
10016 B250:0/15 : 0_

Connected 0:08:40 ANSI TCP/IP SCROLL CAPS NUM Capture Print echo

```

Setup Screen #7 of 8
“MODBUS/DF1 Register Realtime Display 2 of 2”

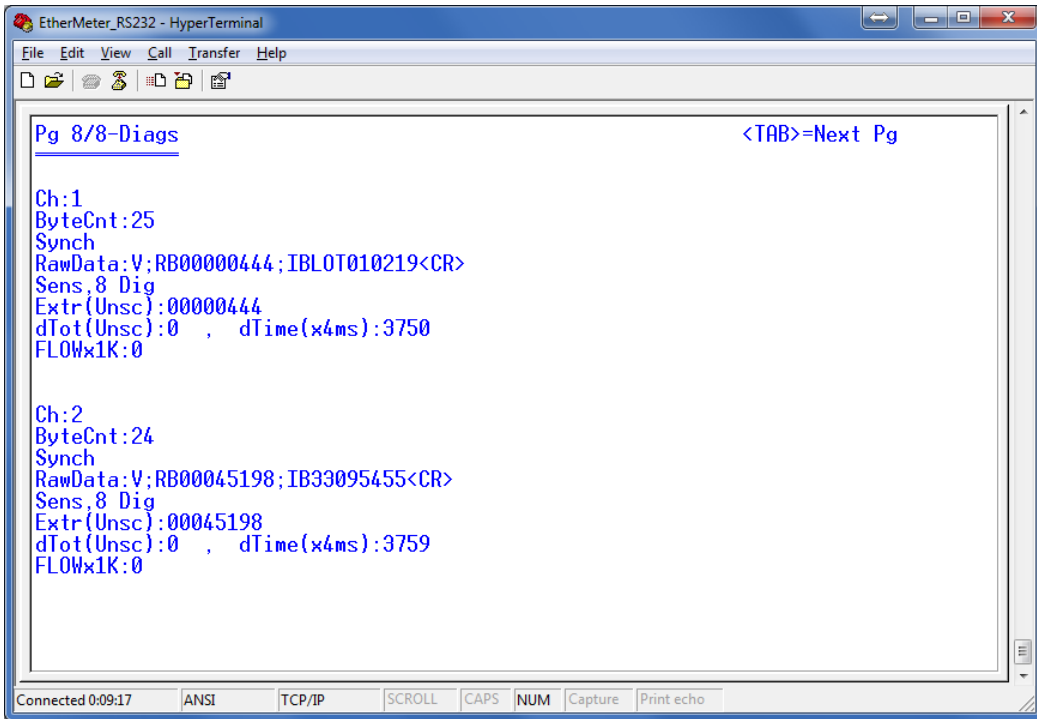

Setup Screen #8 of 8
“Meter Read Diagnostics”

Customizing The EtherMeter Through The Setup Menu

Setup commands are entered at the "CMD>" prompt. After each command is entered, it is recommended that the technician verify the modified setting on the Setup Menu Display. For example, to set the run-mode baud rate to 19200, type: SET BAUD 19200 <ENTER>

SETUP MODE COMMANDS:

METER SETUP	SELECTIONS	DEFAULTS
SET UNIT1	GAL, L, FT3, M3, LB, KG, AF, UNITS (AF = ACRE-FT; FT3=CUBIC FT; M3=CUBIC METERS. OTHERWISE SELF EXPLANATORY)	GAL
SET UNIT2	GAL, L, FT3, M3, LB, KG, AF, UNITS	GAL
SET TB1	SECOND, MINUTE, HOUR TIMEBASE FOR FLOW RATE CALCULATIONS. FOR EXAMPLE... IF UNITn=GALLONS AND IF TBn=MINUTE, THEN THE FLOW RATE WILL BE DISPLAYED AND REPORTED IN UNITS OF GALLONS/MINUTE. EXCEPTION: WHEN UNITn=AF (ACRE-FT), FLOW RATE WILL BE DISPLAYED AND REPORTED IN GALLONS / MINUTE,SEC,HR	MIN
SET TB2	SECOND, MINUTE, HOUR	MIN
SET EXP1	-8, -7, -6, -5,-4,-3,-2,-1,0,1,2,3,4,5,6,7,8 SPECIFIES THE PLACEMENT OF THE DECIMAL POINT FOR METER 1. '0' CORRESPONDS TO NOT MOVING THE DECIMAL POINT... '-1' CORRESPONDS TO MOVING THE DECIMAL POINT ONE DIGIT TO THE LEFT... '+1' CORRESPONDS TO MOVING THE DECIMAL POINT ONE DIGIT TO THE RIGHT, ETC... NOTE THAT THIS SETTING SCALES THE TOTAL AND FLOW AS DISPLAYED ON THE 2X16 LCD DISPLAY AND WEB PAGE. HOWEVER, THIS SETTING DOES NOT SCALE THE REPORTED TOTALS IN MODBUS REGISTERS 40001-40004 AND DF1 REGISTERS N7:0-3.	0
SET EXP2	-8, -7, -6, -5,-4,-3,-2,-1,0,1,2,3,4,5,6,7,8	0
SET ROLL1	-999...-5,-4,-3,-2,-1,0,1,2,3,4,5...999 DEVICE WILL COUNT METER ROLLOVERS. USER MAY PRE-LOAD THESE REGISTERS.	0
SET ROLL2	-999...-5,-4,-3,-2,-1,0,1,2,3,4,5...999	0
SET FCALC1	DTIME (Fixed dTime), DTOTAL (Fixed dTotal) SPECIFIES THE FLOW RATE CALCULATION METHOD: DTIME: <ul style="list-style-type: none"> • FIXED DELTA TIME (EG. 30 SECS) • BEST FOR REGISTER WITH 8 WHEELS • FLOW = DELTA-TOTAL / DELTA-TIME (FIXED WINDOW = 4 x DTIME). • FLOW RATE IS RE-CALCULATED AFTER EACH SAMPLE. (SEE SAMP1) DTOTAL: <ul style="list-style-type: none"> • FIXED DELTA TOTAL (EG. 1000 GAL) • BEST FOR REGISTERS WITH 6 OR FEWER WHEELS • FLOW = DTOTAL (FIXED) / DTIME • FLOW RATE IS RE-CALCULATED WHEN THE REGISTER REPORTS A NEW TOTAL, UNLESS TIMEOUT1 HAS ELAPSED. 	DTIME
SET FCALC2	DTIME (Fixed dTime), DTOTAL (Fixed dTotal)	DTIME
SET SAMP1	N (secs) (Meter 1 Sample Period) TIME (SECS) BETWEEN METER READS IF FLOWCALCn=DTIME, SET SAMPn TO 8-45 SECS (TYPICAL). IF FLOWCALCn=DTOTAL, SET SAMPn TO 3-15 SECS (TYPICAL). VALID RANGE: 1-28800	15
SET SAMP2	N (secs) (Meter 2 Sample Period)	15

SET TO1	N (secs) (Flow Timeout For Fixed dTotal) IF USING FIXED DTOTAL FLOW CALC METHOD, AND METER HAS NOT INCREASED, AND TIMEOUT HAS ELAPSED, DISPLAY AND REPORT FLOW RATE AS ZERO. VALID RANGE: 1-28800	300
SET TO2	N (secs) (Flow Timeout For Fixed dTotal)	300
SET TYPE1	Meter 1 Protocol Type AUTO, NEPTUNE, SENSUS, ELSTER, PULSE When set to AUTO, the EtherMeter runs an AUTO-DETECT sequence to determine the correct encoder-type protocol (NEPTUNE, SENSUS, ELSTER). AUTO does not detect pulse-type meters. Therefore, when using a pulse-type meter, the user should always set TYPE1 to PULSE.	AUTO
SET TYPE2	Meter 2 Protocol Type	AUTO
SET DB1	N (msecs) – Debounce Filter Window; VALID RANGE: 0 – 10000 msecs (PULSE-TYPE REGISTERS ONLY) PULSE DURATIONS SHORTER THAN DB1 MSECS ARE IGNORED. DEBOUNCE FILTER IS DISABLED IF DB1=0.	0
SET DB2	N (msecs) – Debounce Filter Window; VALID RANGE: 0 – 10000 msecs	0
SET PD1	N (PULSE DIVIDER); VALID RANGE: 1 – 100,000 USED IN CONJUNCTION WITH PS1. (PULSE-TYPE REGISTERS ONLY) PS1 (PULSE SCALER) and PD1 (PULSE DIVIDER) ARE PARAMETERS USED TO SCALE THE PULSE COUNT INTO ENGINEERING UNITS. FOR EXAMPLE, IF METER 1 EMITS 1431 PULSES PER 1000 GALLONS, THEN PD1 SHOULD BE SET TO 1431 AND PS1 SHOULD BE SET TO 1000.	1
SET PD2	N (PULSE DIVIDER); VALID RANGE: 1 – 100,000 USED IN CONJUNCTION WITH PS2. (PULSE-TYPE REGISTERS ONLY)	1
SET PS1	N (PULSE SCALER); VALID VALUES: 1, 10, 100, 1000, 10000, 100000 USED IN CONJUNCTION WITH PD1. (PULSE-TYPE REGISTERS ONLY) PS1 (PULSE SCALER) and PD1 (PULSE DIVIDER) ARE PARAMETERS USED TO SCALE THE PULSE COUNT INTO ENGINEERING UNITS. FOR EXAMPLE, IF METER 1 EMITS 1431 PULSES PER 1000 GALLONS, THEN PD1 SHOULD BE SET TO 1431 AND PS1 SHOULD BE SET TO 1000.	1
SET PS2	N (PULSE SCALER); VALID VALUES: 1, 10, 100, 1000, 10000, 100000 USED IN CONJUNCTION WITH PD2. (PULSE-TYPE REGISTERS ONLY)	1
SET CNT1	PULSE PRE-SET COUNT; VALID RANGE: 0 – 999999999 (PULSE-TYPE REGISTERS ONLY)	0
SET CNT2	PULSE PRE-SET COUNT; VALID RANGE: 0 – 999999999	0
SET SIMULATION	OFF, ON • ON: ETHERMETER REPORTS METER1 REGISTER AS 12345678, AND FLOW1 REGISTER TO -12345678. USEFUL FOR OFFLINE TESTING. NOTE: SIMULATION MODE IS ALWAYS CLEARED AFTER REBOOT. • OFF: ETHERMETER REPORTS ACTUAL REGISTER CONTENTS. • WHEN SIMULATION=ON, THE SETUP MENU PROMPT IS: SIMUL> WHEN SIMULATION=OFF, THE SETUP MENU PROMPT IS: CMD>	OFF

SERIAL PORT SETUP	SELECTIONS	DEFAULTS
SET ADDRESS	N (decimal) (Protocol-Specific) DEVICE ADDRESS FOR MODBUS, DF1, AND ADAM-4000 PROTOCOLS. ETHERMETER DOES NOT CHECK ADDRESS FOR RANGE VALIDITY.	4 (decimal)
SET PROTOCOL	MB-RTU, MB-ASCII, DF1-FD, DF1-RM, ASCII (ASCII-VERSION ONLY), DISPLAY (DISPLAY-VERSION ONLY), ADAM (ADAM-VERSION ONLY) (SELF EXPLANATORY)	MB-RTU
SET BAUD	N (bps) NOTE: DEVICE CAPABLE OF NON-STANDARD BAUD RATES.	9600
SET SERIALPARAMS	8N1, 7E1, 7O1, 7N2 8N1 (8 Data Bits, No Parity, 1 Stop Bit) 7E1 (7 Data Bits, Even Parity, 1 Stop Bit) 7O1 (7 Data Bits, Odd Parity, 1 Stop Bit) 7N2 (7 Data Bits, No Parity, 2 Stop Bits)	8N1
SET FLOW-CTRL	FIXEDRTS, NULLMODEM, HANDSHAKE, NONE FIXEDRTS (USE FOR CERTAIN "DUMB" MODEMS & RS-485): • DELAY BEFORE RESPONSE FOR FIXED TIME, • THEN RAISE RTS FOR FIXED TIME, • TRANSMIT DATA • HOLD RTS HIGH FOR FIXED TIME NULL-MODEM: • TRANSMITS IF/WHILE CTS IS HIGH. • LOWERS RTS IF/WHILE RCV BUFFER FULL. HANDSHAKE (USE FOR CERTAIN "SMART" MODEMS): • RAISE RTS WHEN DATA IS READY TO TRANSMIT. • BUT WAIT FOR CTS RCV'D FROM MASTER BEFORE XMT. NONE (USE FOR CERTAIN "SMART" MODEMS): • NO HARDWARE FLOW CONTROL • ACTIVE WIRES: TXD, RXD, AND GND NOTE: SOFTWARE FLOW CONTROL IS NOT SUPPORTED.	FIXEDRTS
SET RESP-DELAY-US	N (usecs) • USED WITH "FIXEDRTS" FLOW CONTROL ONLY. • TIME DELAY BEFORE RESPONDING TO A REQUEST BY A MASTER. • USEFUL FOR TUNING RS-485 OR RADIO-MODEM TIMING. • IMPLEMENTED INTERNALLY IN MULTIPLES OF 208 MICROSECONDS.	0
SET PRE-RTS-US	N (usecs) • USED WITH "FIXEDRTS" FLOW CONTROL ONLY. • AFTER RESP-DELAY-US, THIS IS THE TIME DELAY WHILE HOLDING RTS HIGH. • USEFUL FOR TUNING RS-485 OR RADIO-MODEM TIMING. • IMPLEMENTED INTERNALLY IN MULTIPLES OF 208 MICROSECONDS.	1000
SET POST-RTS-US	N (usecs) • USED WITH "FIXEDRTS" FLOW CONTROL ONLY. • AFTER DATA IS COMPLETELY TRANSMITTED, THIS IS THE TIME DELAY FOR HOLDING RTS HIGH. • USEFUL FOR TUNING RS-485 OR RADIO-MODEM TIMING. • IMPLEMENTED INTERNALLY IN MULTIPLES OF 208 MICROSECONDS.	0

SET COLL-AVOID-US	<p>N (usecs)</p> <ul style="list-style-type: none"> • USED WITH "FIXEDRTS" FLOW CONTROL ONLY. • IF NON-ZERO, TRANSMITTER WILL WAIT UP TO N MICROSECONDS FOR DCD TO GO LOW BEFORE TRANSMITTING. • USEFUL FOR IMPLEMENTING COLLISION-AVOIDANCE WITH "DUMB" RADIO-MODEMS. • IMPLEMENTED INTERNALLY IN MULTIPLES OF 208 MICROSECONDS. 	0
SET NHALFBYTES	<p>N (halfbytes)</p> <ul style="list-style-type: none"> • MODIFIES MODBUS/RTU AND DF1 SERIAL RECEPTION BEHAVIOR. DURING DATA PACKET RECEPTION, AFTER "N" HALF-BYTE TIME PERIODS HAVE ELAPSED WITH NO FURTHER DATA RECEIVED, THEN END-OF-PACKET IS ASSUMED. DOES NOT AFFECT MODBUS/ASCII OR ADAM-4000 RECEPTION BEHAVIOR. • MODIFYING THIS SETTING MAY IMPROVE RECEPTION RELIABILITY WHEN USING AN UNCONDITIONED (EG. BELL-202) RADIO-MODEM. 	7 (MODBUS/RTU DEFAULT = 7, EQUIVALENT TO 3.5 BYTE TIMES)

MODBUS SETUP	SELECTIONS	DEFAULTS
SET END16	BIG-ENDIAN, LITTLE-ENDIAN <ul style="list-style-type: none"> • BIG-ENDIAN – MS (MOST SIGNIFICANT) BYTE TRANSMITTED FIRST • LITTLE-ENDIAN – LS (LEAST SIGNIFICANT) BYTE TRANSMITTED FIRST 	BIG-ENDIAN
SET END32	BIG-ENDIAN, LITTLE-ENDIAN <ul style="list-style-type: none"> • BIG-ENDIAN – MS (MOST SIGNIFICANT) WORD TRANSMITTED FIRST • LITTLE-ENDIAN – LS (LEAST SIGNIFICANT) WORD TRANSMITTED FIRST 	BIG-ENDIAN
DF1 SETUP	SELECTIONS	DEFAULTS
SET DF1CHK	CRC, BCC <ul style="list-style-type: none"> • CRC (DEFAULT) – USE 16-BIT CRC ERROR CHECKING • BCC – USE 8-BIT CHECKSUM 	CRC
ADAM-4000 SETUP	SELECTIONS	DEFAULTS
SET ADMCHK (ADAM-VERSION ONLY)	OFF, ON <ul style="list-style-type: none"> • OFF (ADAM-4000 DEFAULT) – TURN OFF CHECKSUM ERROR CHECKING • ON – TURN ON CHECKSUM ERROR CHECKING 	OFF
NETWORK SETUP	SELECTIONS	DEFAULTS
SET DHCP	OFF, ON <ul style="list-style-type: none"> • OFF (DEFAULT) – USE DEFAULT IP ADDRESS, GATEWAY ADDRESS, AND NETMASK. • ON – USE DHCP TO FETCH IP ADDRESS, GATEWAY ADDRESS, AND NETMASK. 	ON
SET IP	nnn.nnn.nnn.nnn <ul style="list-style-type: none"> • DEFAULT IP ADDRESS • IGNORED WHEN DHCP IS ON 	192.168.1.140
SET GATEWAY	nnn.nnn.nnn.nnn <ul style="list-style-type: none"> • DEFAULT GATEWAY ADDRESS • IGNORED WHEN DHCP IS ON 	192.168.1.1
SET NETMASK	nnn.nnn.nnn.nnn <ul style="list-style-type: none"> • DEFAULT NETMASK • IGNORED WHEN DHCP IS ON 	255.255.255.0
SET DUPLEX	HALF, FULL <ul style="list-style-type: none"> • HALF (DEFAULT) – USE 10BASET HALF DUPLEX • FULL – USE 10BASET FULL DUPLEX. (NOTE: ETHERMETER DOES NOT AUTO-NEGOTIATE DUPLEX SETTING. IF UNSURE, LEAVE AT DEFAULT SETTING: HALF DUPLEX.)	HALF
SET PASSWORD	AAAAAAA <ul style="list-style-type: none"> • TELNET PASSWORD (CASE INSENSITIVE, 8 CHARS MAX) • TELNET USERNAME IS FIXED AS: EMETER 	EMETER
SET PORT HTTP	1 – 65535 TCP PORT FOR WEB SERVER, 0=DISABLE WEB SERVER	80
SET PORT TELNET	1 – 65535 TCP PORT FOR TELNET SERVER, 0=DISABLE TELNET SERVER	23
SET PORT MBTCP	1 – 65535 TCP PORT FOR MODBUS/TCP, UDP PORT FOR MODBUS/UDP (NOTE! – MODBUS/RTU piped over UDP is available on port MBTCP+1)	502
SET PORT ETHIP	1 – 65535 TCP PORT FOR ETHERNET/IP	44818

AUX I/O SETUP	SELECTIONS	DEFAULTS
SET AUX1	DIN, DOUT, PWRSVHI, PWRSVLO DIN: • DIGITAL INPUT – MAY BE MONITORED BY INTERROGATION FROM MODBUS, DF1, ETHERNET/IP, OR ADAM MASTER DOUT: • DIGITAL OUTPUT – FOLLOWS COMMANDS FROM MODBUS OR DF1 (OR ADAM) MASTER PWRSVHI: • DIGITAL OUTPUT GOES “HI” (5V) TO TURN ON CONNECTED RADIO OR MODEM. PWRSVLO: • DIGITAL OUTPUT GOES “LO” (0V) TO TURN ON CONNECTED RADIO OR MODEM. (FOR PWRSVLO AND PWRSVHI TIMING DIAGRAMS, SEE SECTION 9, RADIO INTERFACE.)	DIN
SET AUX2	DOUT, DIN, DUP DOUT: • DIGITAL OUTPUT – FOLLOWS COMMANDS FROM MODBUS, DF1, ETHERNET/IP, OR ADAM MASTER DIN: • DIGITAL INPUT – MAY BE MONITORED BY INTERROGATION FROM MODBUS, DF1, ETHERNET/IP, OR ADAM MASTER DUP: • CONTROL DUPLEXER OUTPUT – FOR SDA, SDAW, RRFD, RRFW.	DIN
SET AUX3	DOUT, DIN, DUP DOUT: • DIGITAL OUTPUT – FOLLOWS COMMANDS FROM MODBUS, DF1, ETHERNET/IP, OR ADAM MASTER DIN: • DIGITAL INPUT – MAY BE MONITORED BY INTERROGATION FROM MODBUS, DF1, ETHERNET/IP, OR ADAM MASTER DUP: • CONTROL DUPLEXER OUTPUT – FOR SDA, SDAW, RRFD, RRFW	RRF
SET ONTIME	N (secs) • USED WHEN DOUT1=PWRSVHI OR PWRSVLO • TIME TO LEAVE RADIO ON AFTER THE RECEIPT OF A POLL REQUEST ADDRESSED TO THIS DEVICE. • FOR TIMING DIAGRAM, SEE SECTION 9, RADIO INTERFACE.	60 (1 min)
SET OFFTIME	N (secs) • AFTER RECEIPT OF POLL REQUEST AND AFTER ONTIME ELAPSED, TIME TO LEAVE RADIO OFF. • AFTER OFFTIME ELAPSES, RADIO WILL BE TURNED OFF AND DEVICE WILL WAIT FOR NEXT POLL REQUEST. • FOR TIMING DIAGRAM, SEE SECTION 9, RADIO INTERFACE.	21240 (5 hrs,54min)

SET FAILSAFE	<p>NONE, ON, OFF</p> <p>ON: • WHEN POLL NOT RECEIVED FOR FAILTIME (SECS), TURN DIGITAL OUTPUT(S) ON.</p> <p>OFF: • WHEN POLL NOT RECEIVED FOR FAILTIME (SECS), TURN DIGITAL OUTPUT(S) OFF.</p> <p>NONE: • IGNORE FAILTIME.</p> <p>(‘FAILSAFE’ SETTING ONLY AFFECTS AUXILIARY OUTPUT(S) WHEN AUXn=DOUT.)</p>	NONE
SET FAILTIME	<p>N (secs)</p> <p>WHEN POLL NOT RECEIVED AFTER FAILTIME (SECS) HAS ELAPSED, DIGITAL OUTPUT(S) PUT INTO FAILSAFE STATE (ON OR OFF).</p> <p>(‘FAILTIME’ SETTING ONLY AFFECTS AUXILIARY OUTPUT(S) WHEN FAILSAFE=ON/OFF AND AUXn=DOUT)</p>	60
WDETH_MIN	<p>0-20160 minutes</p> <p>“WATCHDOG TIMER – ETHERNET COMMS”</p> <p>WHEN ETHERNET PORT POLL (MODBUS/TCP/UDP, ETHERNET/IP) NOT RECEIVED AFTER WDSER_MIN (MINUTES) HAS ELAPSED, THEN THE ETHERMETER REBOOTS. 0=DISABLED.</p> <p>POTENTIALLY USEFUL MECHANISM TO DETECT AND RESET CORRUPTED COMMUNICATIONS THAT CAN OCCUR OVER UNRELIABLE WIRELESS AND CELLULAR DATA LINKS.</p>	0 (0=DISABLED)
WDSER_MIN	<p>0-20160 minutes</p> <p>“WATCHDOG TIMER – SERIAL COMMS”</p> <p>WHEN SERIAL PORT POLL (MODBUS/RTU/ASCII, DF1) NOT RECEIVED AFTER WDSER_MIN (MINUTES) HAS ELAPSED, THEN THE ETHERMETER REBOOTS. 0=DISABLED.</p> <p>POTENTIALLY USEFUL MECHANISM TO DETECT AND RESET CORRUPTED COMMUNICATIONS THAT CAN OCCUR OVER UNRELIABLE WIRELESS AND CELLULAR DATA LINKS.</p>	0 (0=DISABLED)
	<p>MA, V</p> <p>MA: 0 (0%) → 4 MA 10000 (100%) → 20 MA</p> <p>V: 0 (0%) → 0 V 10000 (100%) → 5 V</p> <p>(NOTE: FOR 0-5V INPUT, REMOVE J4)</p>	
SET AIN1	<p>MA, V</p> <p>MA: 0 (0%) → 4 MA 10000 (100%) → 20 MA</p> <p>V: 0 (0%) → 0 V 10000 (100%) → 5 V</p> <p>(NOTE: FOR 0-5V INPUT, REMOVE J5)</p>	MA
SET AIN2	A/D CONVERTER CONSTANT 1 - FACTORY USE ONLY	MA
SET ADCONST	<p>0, 1, 2, 3, 4, 5, 6</p> <p>A/D CONVERTER CONSTANT 2 - FACTORY USE ONLY</p>	1000
SET ADSHIFT	FACTORY USE ONLY – SMOOTHING FILTER FOR ANALOG INPUTS	6

INTERFACE SETUP	SELECTIONS	DEFAULTS
SET LCD01	<p>AUTO, ON, OFF</p> <p>CONTROLS LCD DISPLAY OF METER #1 TOTALIZATION.</p> <p>AUTO: DISPLAY ACTIVE WHEN METER #1 DETECTED.</p> <p>ON: DISPLAY ACTIVE, REGARDLESS OF WHETHER METER 1 DETECTED.</p> <p>OFF: SUPPRESSES DISPLAY.</p> <p>NOTE: FOR CONVENIENCE, <u>ALL</u> LCD SCREENS ARE SEQUENTIALLY DISPLAYED RIGHT AFTER POWERUP AND RIGHT AFTER SWITCHING FROM SETUP MODE TO RUN MODE (DIP SWITCH #8).</p>	AUTO
SET LCD02	<p>AUTO, ON, OFF</p> <p>CONTROLS LCD DISPLAY OF METER #2 TOTALIZATION.</p> <p>AUTO: DISPLAY ACTIVE WHEN METER #2 DETECTED.</p> <p>ON: DISPLAY ACTIVE, REGARDLESS OF WHETHER METER #2 DETECTED.</p> <p>OFF: SUPPRESSES DISPLAY.</p>	AUTO
SET LCD03	<p>AUTO, ON, OFF</p> <p>CONTROLS LCD DISPLAY OF METER #1 FLOW RATE.</p> <p>AUTO: DISPLAY ACTIVE WHEN METER #1 DETECTED.</p> <p>ON: DISPLAY ACTIVE, REGARDLESS OF WHETHER METER #1 DETECTED.</p> <p>OFF: SUPPRESSES DISPLAY.</p>	AUTO
SET LCD04	<p>AUTO, ON, OFF</p> <p>CONTROLS LCD DISPLAY OF METER #2 FLOW RATE.</p> <p>AUTO: DISPLAY ACTIVE WHEN METER #2 DETECTED.</p> <p>ON: DISPLAY ACTIVE, REGARDLESS OF WHETHER METER #2 DETECTED.</p> <p>OFF: SUPPRESSES DISPLAY.</p>	AUTO
SET LCD05	<p>ON, OFF</p> <p>CONTROLS LCD DISPLAY OF POWER SUPPLY VOLTAGE.</p> <p>ON: DISPLAY ACTIVE.</p> <p>OFF: SUPPRESSES DISPLAY.</p>	OFF
SET LCD06	<p>ON, OFF</p> <p>CONTROLS LCD DISPLAY OF ANALOG INPUT #1.</p> <p>ON: DISPLAY ACTIVE.</p> <p>OFF: SUPPRESSES DISPLAY.</p>	OFF

SET LCD07	ON, OFF CONTROLS LCD DISPLAY OF ANALOG INPUT #2. ON: DISPLAY ACTIVE. OFF: SUPPRESSES DISPLAY.	OFF
SET LCD08	ON, OFF CONTROLS LCD DISPLAY OF AUX DIGITAL I/O #1. ON: DISPLAY ACTIVE. OFF: SUPPRESSES DISPLAY.	OFF
SET LCD09	ON, OFF CONTROLS LCD DISPLAY OF AUX DIGITAL I/O #2. ON: DISPLAY ACTIVE. OFF: SUPPRESSES DISPLAY.	OFF
SET LCD10	ON, OFF CONTROLS LCD DISPLAY OF AUX DIGITAL I/O #3. ON: DISPLAY ACTIVE. OFF: SUPPRESSES DISPLAY.	OFF
SET LCD11	ON, OFF CONTROLS LCD DISPLAY OF DEVICE UPTIME (MINUTES). ON: DISPLAY ACTIVE. OFF: SUPPRESSES DISPLAY.	OFF
SET LCD12	ON, OFF CONTROLS LCD DISPLAY OF ACTIVE SERIAL PROTOCOL. ON: DISPLAY ACTIVE. OFF: SUPPRESSES DISPLAY.	OFF
SET LCD13	ON, OFF CONTROLS LCD DISPLAY OF DEVICE (ETHERNET) ADDRESS. ON: DISPLAY ACTIVE. OFF: SUPPRESSES DISPLAY.	OFF
SET LCD14	ON, OFF CONTROLS LCD DISPLAY OF FIRMWARE VERSION. ON: DISPLAY ACTIVE. OFF: SUPPRESSES DISPLAY.	OFF

SET LCD15	AUTO, ON, OFF CONTROLS LCD DISPLAY OF BANNER TEXT. AUTO: DISPLAYS WHEN BANNER TEXT EXISTS (WHEN BANNER TEXT HAS BEEN ENTERED BY THE USER). ON: DISPLAY ACTIVE. OFF: SUPPRESSES DISPLAY.	AUTO
SET DESCR1	TEXT DESCRIPTION FOR THE METER ATTACHED TO CHANNEL 1 (1 TO 4 CHARACTERS, NO SPACES OR PERIODS).	1
SET DESCR2	TEXT DESCRIPTION FOR THE METER ATTACHED TO CHANNEL 2 (1 TO 4 CHARACTERS, NO SPACES OR PERIODS).	2
SET BANNER	TEXT DESCRIPTION FOR THE ETHERMETER'S LOCATION/PURPOSE/ETC... (1 TO 32 CHARACTERS). NOTE 1: THE BANNER TEXT ENTERED SHOULD NOT CONTAIN ANY SPACES OR PERIODS. UNDERSCORES SHOULD BE ENTERED IN LIEU OF SPACES WHEREVER NEEDED. THE ETHERMETER WILL AUTOMATICALLY REPLACE THE UNDERSCORES WITH SPACES ON THE LCD DISPLAY, WEB PAGE, AND SETUP MENU. NOTE 2: TO CLEAR THE BANNER TEXT, TYPE: "SET BANNER<ENTER>"	<BLANK>

NOTE 1: THE UNIT EXECUTES A SOFT RESTART WHEN "REBOOT" IS ENTERED AT THE COMMAND PROMPT.

NOTE 2: THE FACTORY DEFAULT SETTINGS ARE RESTORED WHEN "FACTORYRESET" IS ENTERED AT THE COMMAND PROMPT.

14 MODBUS PROTOCOL SUPPORT

This manual assumes that the user is well-versed in the MODBUS Protocol. In order to learn more about the MODBUS protocol, visit modicon.com or modbus.org.

The following subset of the MODBUS protocol is supported by the EtherMeter:

- 01 - Read Coil Status
- 02 - Read Input Status
- 03 - Read Holding Registers
- 04 - Read Input Registers (Mirrors Function 03)
- 05 - Force Single Coil
- 06 - Write Single (Holding) Register
- 15 - Force Multiple Coils

The default byte-order is “high-byte / low-byte” and the default word order is “high-word / low-word”. This method of ordering is also known as “Big-Endian”. However, the MODBUS byte-order and word-order can be modified through the Setup Menu.

In keeping with MODBUS/TCP protocol specifications, The EtherMeter ignores the “Device Address” field that is transmitted within all MODBUS/TCP/UDP requests, as the EtherMeter is sufficiently distinguished by its IP address. Please note that fragmented MODBUS/TCP/UDP packets are not supported.

Although there is not a defined MODBUS/UDP standard, the EtherMeter’s implementation has been compatibility tested with KepServerEx, Digi One IAP, and likely other software and devices.

To test and/or verify MODBUS communications with the EtherMeter, there are several useful computer programs available. SCADAmetrics recommends the SimplyModbusRTU and SimplyModbusTCP programs, which are available for a modest price from www.simplymodbus.ca. Assistance and support for these programs (and all 3rd-party software) may be obtained from their respective manufacturers.

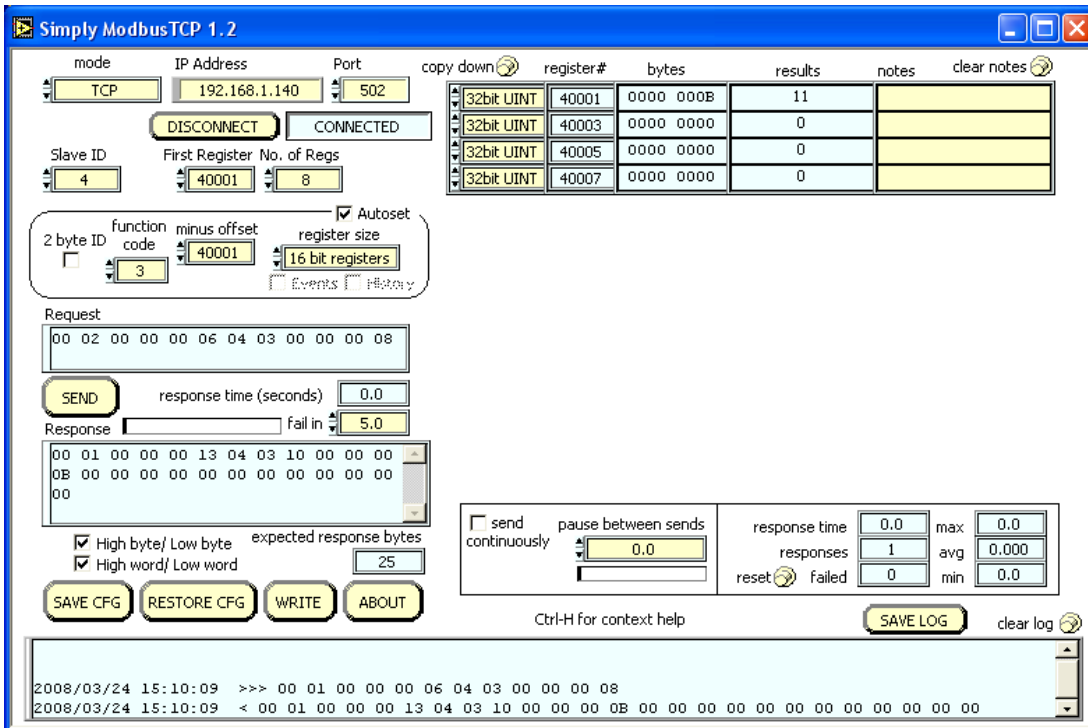

Figure 14A. A Screen Snapshot of the Simply Modbus TCP Client.

FUNCTION: 03(READ)

REGISTERS

DESCRIPTORS

40001,40002*	METER 1 TOTAL (UNSCALED)
40003,40004*	METER 2 TOTAL (UNSCALED)
40005,40006**	FLOW 1 X 1000
40007,40008**	FLOW 2 X 1000
40009	ROLLOVERS – METER 1
40010	ROLLOVERS – METER 2
40011	AIN 1 (0-10000)
40012	AIN 2 (0-10000)
40013	SUPPLY VOLTS X 10
40014	DIGITAL STATUS BITS (See Details Next Page)
40015	METER 1 READ FAULT
40016	METER 2 READ FAULT
40017,40018*	SYSTEM UPTIME (MINUTES)
40019	METER 1 nDIGITS
40020	METER 2 nDIGITS
40021	METER 1 EXPONENT
40022	METER 2 EXPONENT
40023	METER 1 UNITS (See Figure 14B for Details)
40024	METER 2 UNITS (See Figure 14B for Details)
40025	METER 1 READ FAULT COUNTER
40026	METER 2 READ FAULT COUNTER

*DATA OCCUPYING THESE REGISTERS ARE 32-BIT UNSIGNED LONG INTEGERS.

**DATA OCCUPYING THESE REGISTERS ARE 32-BIT SIGNED LONG INTEGERS.

ALL OTHERS ARE 16-BIT SIGNED INTEGERS

FUNCTION: 02(READ)

INPUTS

DESCRIPTORS

10001	AUX DIGITAL I/O 1
10002	AUX DIGITAL I/O 2
10003	AUX DIGITAL I/O 3
10004-10008	-reserved/future-
10009	METER 1 READ FAULT
10010	METER 2 READ FAULT
10011	METER 1 FWD FLOW (Y/N)
10012	METER 2 FWD FLOW (Y/N)
10013	METER 1 REV FLOW (Y/N)
10014	METER 2 REV FLOW (Y/N)
10015-10016	-reserved/future-

FUNCTION: 01(READ) / 05(WRITE) / 15(WRITE)

COILS

DESCRIPTOR

00001	AUX DIGITAL OUTPUT 1
00002	AUX DIGITAL OUTPUT 2
00003	AUX DIGITAL OUTPUT 3
00004	REBOOT DEVICE
00005-00008	-reserved/future-
00009	RESET CNT1 to ZERO (When Meter Ch. 1 Configured As Pulse Input)
00010	RESET CNT2 to ZERO (When Meter Ch. 2 Configured As Pulse Input)
00011-00016	-reserved/future-

EtherMeter MODBUS Register Map.

Modbus Register 40014 contains the 16-bit word: “**Digital Status Bits**”. The contents of this word are as illustrated in the following table:

Bit Position	Contents
00 (Least Significant Bit)	Aux Digital I/O 1 Status (1=ON, 0=OFF)
01	Aux Digital I/O 2 Status (1=ON, 0=OFF)
02	Aux Digital I/O 3 Status (1=ON, 0=OFF)
03	REBOOT DEVICE
04	-reserved/future-
05	-reserved/future-
06	-reserved/future-
07	-reserved/future-
08	Meter 1 Read Fault (1=Fault, 0=OK)
09	Meter 2 Read Fault (1=Fault, 0=OK)
10	Meter 1 Fwd Flow (1=Fwd Flow)
11	Meter 2 Fwd Flow (1=Fwd Flow)
12	Meter 1 Rev Flow (1=Rev Flow)
13	Meter 2 Rev Flow (1=Rev Flow)
14	-reserved/future-
15 (Most Significant Bit)	-reserved/future-

For example, if **Register 40014** contains the following:

0000 1100 0000 0111 (Binary)... or 0C07 (Hexadecimal)... or 3079 (Decimal)

Then the following status conditions exist:

Aux Digital I/O 1	1	ON
Aux Digital I/O 2	1	ON
Aux Digital I/O 3	1	ON
REBOOT DEVICE	0	-N/A-
-N/A-	0	-N/A-
-N/A-	0	-N/A-
-N/A-	0	-N/A-
-N/A-	0	-N/A-
Meter 1 Read Fault	0	OFF (OK)
Meter 2 Read Fault	0	OFF (OK)
Meter 1 Fwd Flow	1	ON
Meter 2 Fwd Flow	1	ON
Meter 1 Rev Flow	0	OFF
Meter 2 Rev Flow	0	OFF
-N/A-	0	-N/A-
-N/A-	0	-N/A-

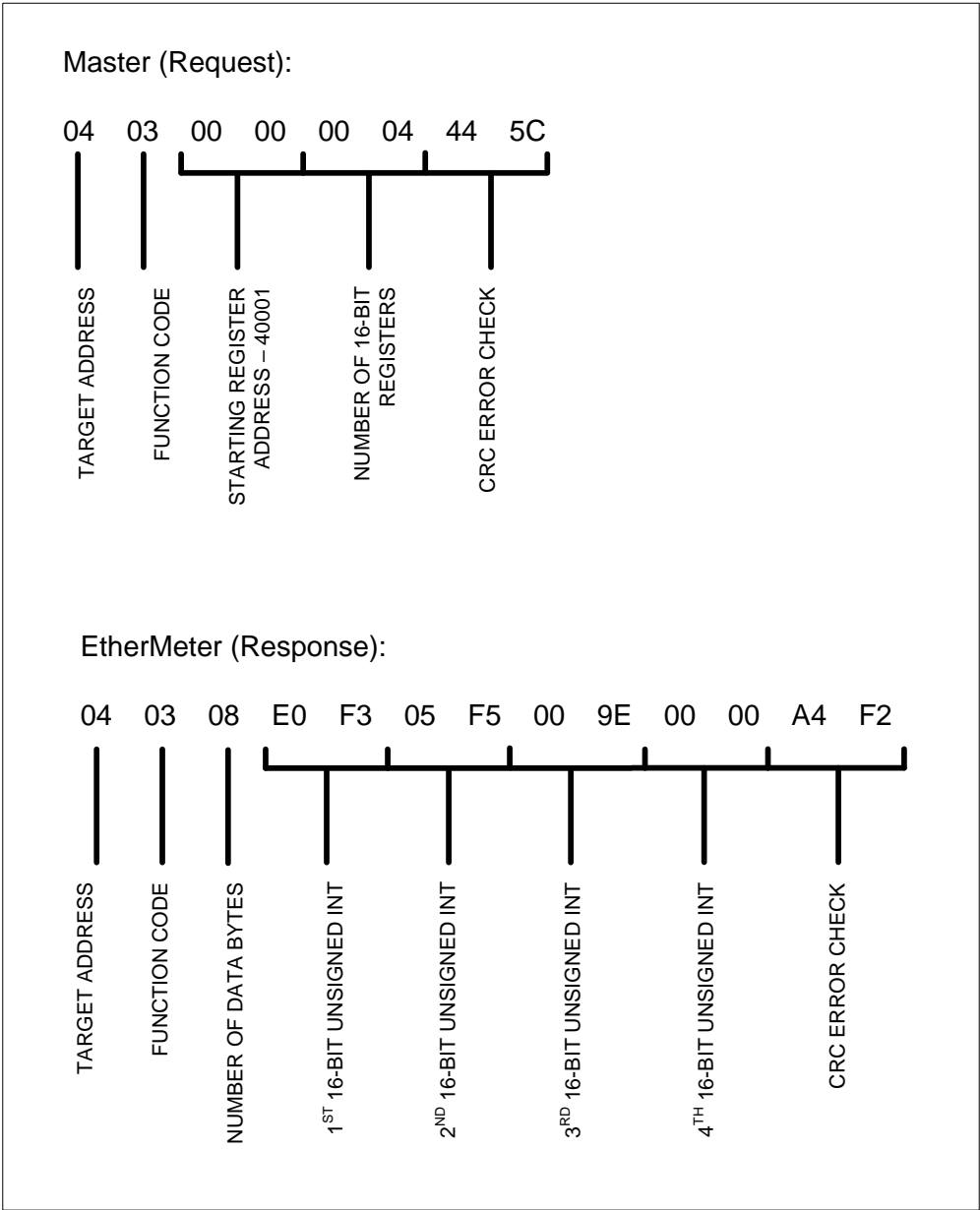

Example MODBUS Request/Response.

Sample MODBUS/RTU Commands:

The following samples are provided to familiarize the user with a few of the core EtherMeter MODBUS/RTU commands. In all samples, the device address=4. Note that the users' responses will vary in accordance with the unique I/O state of each EtherMeter.

Read: Meter 1, Meter 2, Flow 1, Flow 2 MODBUS Function 3

Request: 04 03 00 00 00 08 44 59
Response (example): 04 03 10 00 00 00 2F 00 00 02 0C 00 00 00 00 00 00 00 00 00 B7 30

Read: Eight (8) Digital Inputs MODBUS Function 2

Request: 04 02 00 00 00 08 79 99
Response (example): 04 02 01 03 E1 45

Write: Turn 1st Coil ON (Aux Digital I/O 1) MODBUS Function 5

Request: 04 05 00 00 FF 00 8C 6F
Response (example): 04 05 00 00 FF 00 8C 6F

Write: Turn 1st Coil OFF (Aux Digital I/O 1) MODBUS Function 5

Request: 04 05 00 00 00 00 CD 9F
Response (example): 04 05 00 00 00 00 CD 9F

Write: Turn 2nd Coil ON (Aux Digital I/O 2) MODBUS Function 5

Request: 04 05 00 01 FF 00 DD AF
Response (example): 04 05 00 01 FF 00 DD AF

Write: Turn 2nd Coil OFF (Aux Digital I/O 2) MODBUS Function 5

Request: 04 05 00 01 00 00 9C 5F
Response (example): 04 05 00 01 00 00 9C 5F

TOTALIZATION AND FLOW DATA FORMAT:

The EtherMeter was designed in such a way as to simplify and compress the formatting of all reported data. As shown in the previous charts, no floating point or 64-bit registers are implemented in the holding (4xxxx) registers, as all data is represented internally as 32-bit long integers (signed or unsigned) and 16-bit signed integers.

In order to achieve a high level of simplicity and prevent integer overflows, separate exponential scale factors and multipliers are provided in certain MODBUS registers.

If fully-scaled totalization data is desired, then 64-bit data processing may be required by the MODBUS master polling PLC or computer. In most instances, however, 32-bit data manipulation will suffice.

TOTALIZATION HELPER FORMULAS:

The following calculations are examples helper formulas that may be implemented within the master. When deciding whether to use 64-bit versus 32-bit data manipulation routines at the master, it is recommended that the user factor in the largest expected meter totalization value (meter-specific), and consider that the largest possible 32-bit unsigned long integer is 4,294,967,295.

$$\begin{aligned} \text{Meter 1 Actual Total} &= ([\text{METER 1 TOTAL UNSCALED}] \times [10^{[\text{METER 1 EXPONENT}]}]) \\ &+ ([\text{ROLLOVERS METER 1}] \times [10^{[\text{METER 1 nDIGITS}]}] \times [10^{[\text{METER 1 EXPONENT}]}]) \\ &= ([40001,40002] \times [10^{[40021]}]) + ([40009] \times [10^{[40019]}] \times [10^{[40021]}]) \end{aligned}$$

$$\begin{aligned} \text{Meter 2 Actual Total} &= ([\text{METER 2 TOTAL UNSCALED}] \times [10^{[\text{METER 2 EXPONENT}]}]) \\ &+ ([\text{ROLLOVERS METER 2}] \times [10^{[\text{METER 2 nDIGITS}]}] \times [10^{[\text{METER 2 EXPONENT}]}]) \\ &= ([40003,40004] \times [10^{[40022]}]) + ([40010] \times [10^{[40020]}] \times [10^{[40022]}]) \end{aligned}$$

FLOW RATE HELPER FORMULAS:

The following are possible flow rate helper formulas that may be implemented within a MODBUS master polling PLC or computer:

$$\begin{aligned} \text{Meter 1 Actual Flow} &= [\text{FLOW 1}] / 1000 \\ &= [40005,40006] / 1000 \end{aligned}$$

$$\begin{aligned} \text{Meter 2 Actual Flow} &= [\text{FLOW 2}] / 1000 \\ &= [40007,40008] / 1000 \end{aligned}$$

EXAMPLE:

Consider the following case of a meter register installed on meter channel 1. This register contains 8 variable digits plus two (2) fixed zeros on the right. (EXP1=+2.)

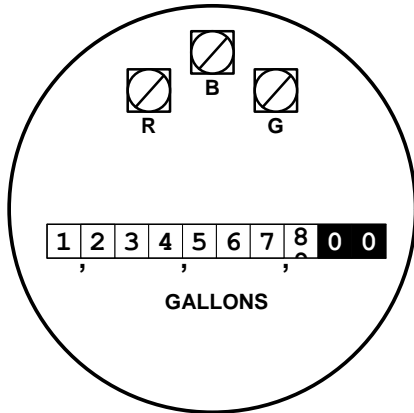

In this case, the actual total is 1,234,567,800 gallons. However, the [40001,40002] MODBUS holding register will report the total as: 12,345,678. If scaling to GALLONS is desired, then the polling device (master) must perform the scaling (multiply by $10^{(EXPn)}$ or $10^{[40022]}$ or 100).

Regarding flow, all reported flow rates are multiplied by 1000 to eliminate the need for floating point formatting within the EtherMeter. In this case, if the actual flow rate is 987.6 GPM, then the [40005,40006] MODBUS holding register will report the flow as 987,600 (milliGallons/minute). If scaling to GPM is desired, then the polling device (master) must perform the floating point conversion and scaling (divide by 1000).

On the LCD display and within the MODBUS flow registers, the following table displays the flow units that pertain to the totalization units:

Totalization Units	Flow Units	Holding Register Value (Registers 40023, 40024)
Gallons	Gallons Per [Hour,Minute,Sec]	0
Liters	Liters Per [Hour,Minute,Sec]	1
Cubic Feet	Cubic Feet Per [Hour,Minute,Sec]	2
Cubic Meters	Cubic Meters Per [Hour,Minute,Sec]	3
Pounds	Pounds Per [Hour,Minute,Sec]	4
Kilograms	Kilograms Per [Hour,Minute,Sec]	5
Acre Feet	Gallons Per [Hour,Minute,Sec]	6
Units	Units Per [Hour,Minute,Sec]	7

Figure 14B. Totalizer Unit Modbus Codes

15 DF1 AND ETHERNET/IP PROTOCOL SUPPORT

DF1. The EtherMeter provides elementary support for Rockwell Automation’s DF1 serial protocol. This manual assumes that the user is well-versed in the DF1 Protocol. In order to learn more about the DF1 protocol, visit rockwellautomation.com.

The following functional subset of the DF1 protocol is supported by the EtherMeter:

- [CMD,FNC] = [0F,A2] - “Protected Typed Logical Read With 3 Address Fields”
- [CMD,FNC] = [0F,AA] - “Protected Typed Logical Write With 3 Address Fields”

To a polling master PLC or computer, the EtherMeter’s data is available within the Integer and Bit registers documented within this section. Read-only, Integer data is stored within the N7:0 register, and read-only Bit data is stored within B250 registers. The three (3) auxiliary digital outputs are mapped to the N10:0 register. When addressing Bit registers, is important to note that misaligned bit blocks, partial words, and masked/scattered bit reads are not supported.

DF1-RadioModem and DF1-FullDuplex are both supported; and DF1-HalfDuplex is not supported. For error checking, either CRC-16 or BCC error checking may be selected.

In the DF1 protocol, the byte-order is “low-byte / high-byte” and the word order is “low-word / high-word”. This method of ordering is also known as “Little-Endian”. The DF1 byte-order and word-order are fixed within the EtherMeter. To ensure Allen-Bradley compatibility, DF1 and EtherNet/IP byte and word ordering cannot be modified through the Setup Menu.

To test and/or verify DF1 communications with the EtherMeter, there are several useful computer programs available. SCADAmetrics recommends KepServerEx from Kepware Technologies (kepware.com), or RSLinx™ from Rockwell Automation (rockwellautomation.com). Assistance and support for these programs (and all 3rd-party software) may be obtained from their respective manufacturers.

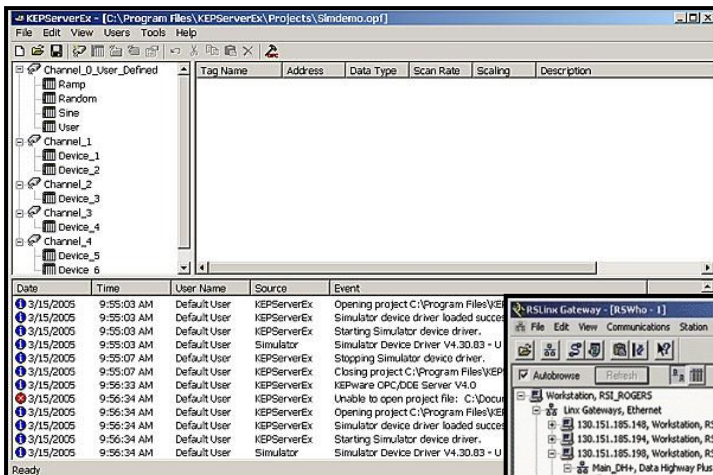

kepserverEX (Kepware Technologies)

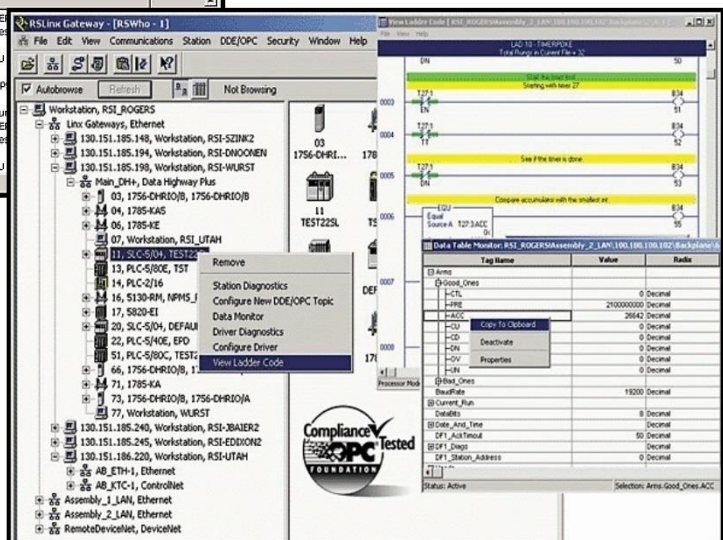

RSLinx (Rockwell Automation)

PROTECTED TYPED LOGICAL READ/WRITE WITH 3 ADDRESS FIELDS

[CMD,FNC,FILE#,FILETYPE] = [0F,A2,07,89] (READ N7 REGISTERS)

<u>REGISTERS</u>	<u>DESCRIPTORS</u>
N7:0-1*	METER 1 TOTAL (UNSCALED)
N7:2-3*	METER 2 TOTAL (UNSCALED)
N7:4-5**	FLOW 1 X 1000
N7:6-7**	FLOW 2 X 1000
N7:8	ROLLOVERS – METER 1
N7:9	ROLLOVERS – METER 2
N7:10	AIN 1 (0-10000)
N7:11	AIN 2 (0-10000)
N7:12	SUPPLY VOLTS X 10
N7:13	DIGITAL STATUS BITS (See Details Next Page)
N7:14	METER 1 READ FAULT
N7:15	METER 2 READ FAULT
N7:16-17*	SYSTEM UPTIME (MINUTES)
N7:18	METER 1 nDIGITS
N7:19	METER 2 nDIGITS
N7:20	METER 1 EXPONENT
N7:21	METER 2 EXPONENT
N7:22	METER 1 UNITS (See Figure 15A for Details)
N7:23	METER 2 UNITS (See Figure 15A for Details)
N7:24	METER 1 READ FAULT COUNTER
N7:25	METER 2 READ FAULT COUNTER

*DATA OCCUPYING THESE REGISTERS ARE 32-BIT UNSIGNED LONG INTEGERS.

**DATA OCCUPYING THESE REGISTERS ARE 32-BIT SIGNED LONG INTEGERS.

ALL OTHERS ARE 16-BIT SIGNED INTEGERS

[CMD,FNC,FILE#,FILETYPE] = [0F,A2,FA,85] (READ B250 REGISTERS)

<u>INPUTS</u>	<u>DESCRIPTORS</u>
B250:0/0	AUX DIGITAL I/O 1
B250:0/1	AUX DIGITAL I/O 2
B250:0/2	AUX DIGITAL I/O 3
B250:0/3-7	-reserved/future-
B250:0/8	METER 1 READ FAULT
B250:0/9	METER 2 READ FAULT
B250:0/10	METER 1 FWD FLOW (Y/N)
B250:0/11	METER 2 FWD FLOW (Y/N)
B250:0/12	METER 1 REV FLOW (Y/N)
B250:0/13	METER 2 REV FLOW (Y/N)
B250:0/14-15	-reserved/future-

[CMD,FNC,FILE#,FILETYPE] = [0F,AA,0A,85] (WRITE B10 REGISTERS)

B10:0/0	AUX DIGITAL OUTPUT 1
B10:0/1	AUX DIGITAL OUTPUT 2
B10:0/2	AUX DIGITAL OUTPUT 3
B10:0/3	REBOOT DEVICE
B10:0/4-7	-reserved/future-
B10:0/8	RESET CNT1 to ZERO (When Meter Ch. 1 Configured As Pulse Input)
B10:0/9	RESET CNT2 to ZERO (When Meter Ch. 2 Configured As Pulse Input)
B10:0/10-15	-reserved/future-

EtherMeter N-File, B-File Register Map.

DF1 Register N7:13 contains the 16-bit word: “**Digital Status Bits**”. The contents of this word are as illustrated in the following table:

Bit Position	Contents
00 (Least Significant Bit)	Aux Digital I/O 1 Status (1=ON, 0=OFF)
01	Aux Digital I/O 2 Status (1=ON, 0=OFF)
02	Aux Digital I/O 3 Status (1=ON, 0=OFF)
03	REBOOT DEVICE
04	-reserved/future-
05	-reserved/future-
06	-reserved/future-
07	-reserved/future-
08	Meter 1 Read Fault (1=Fault, 0=OK)
09	Meter 2 Read Fault (1=Fault, 0=OK)
10	Meter 1 Fwd Flow (1=Fwd Flow)
11	Meter 2 Fwd Flow (1=Fwd Flow)
12	Meter 1 Rev Flow (1=Rev Flow)
13	Meter 2 Rev Flow (1=Rev Flow)
14	-reserved/future-
15 (Most Significant Bit)	-reserved/future-

For example, if **Register N7:13** contains the following:

0000 1100 0000 0111 (Binary)... or 0C07 (Hexadecimal)... or 3079 (Decimal)

Then the following status conditions exist:

Aux Digital I/O 1	1	ON
Aux Digital I/O 2	1	ON
Aux Digital I/O 3	1	ON
REBOOT DEVICE	0	-N/A-
-N/A-	0	-N/A-
-N/A-	0	-N/A-
-N/A-	0	-N/A-
-N/A-	0	-N/A-
Meter 1 Read Fault	0	OFF (OK)
Meter 2 Read Fault	0	OFF (OK)
Meter 1 Fwd Flow	1	ON
Meter 2 Fwd Flow	1	ON
Meter 1 Rev Flow	0	OFF
Meter 2 Rev Flow	0	OFF
-N/A-	0	-N/A-
-N/A-	0	-N/A-

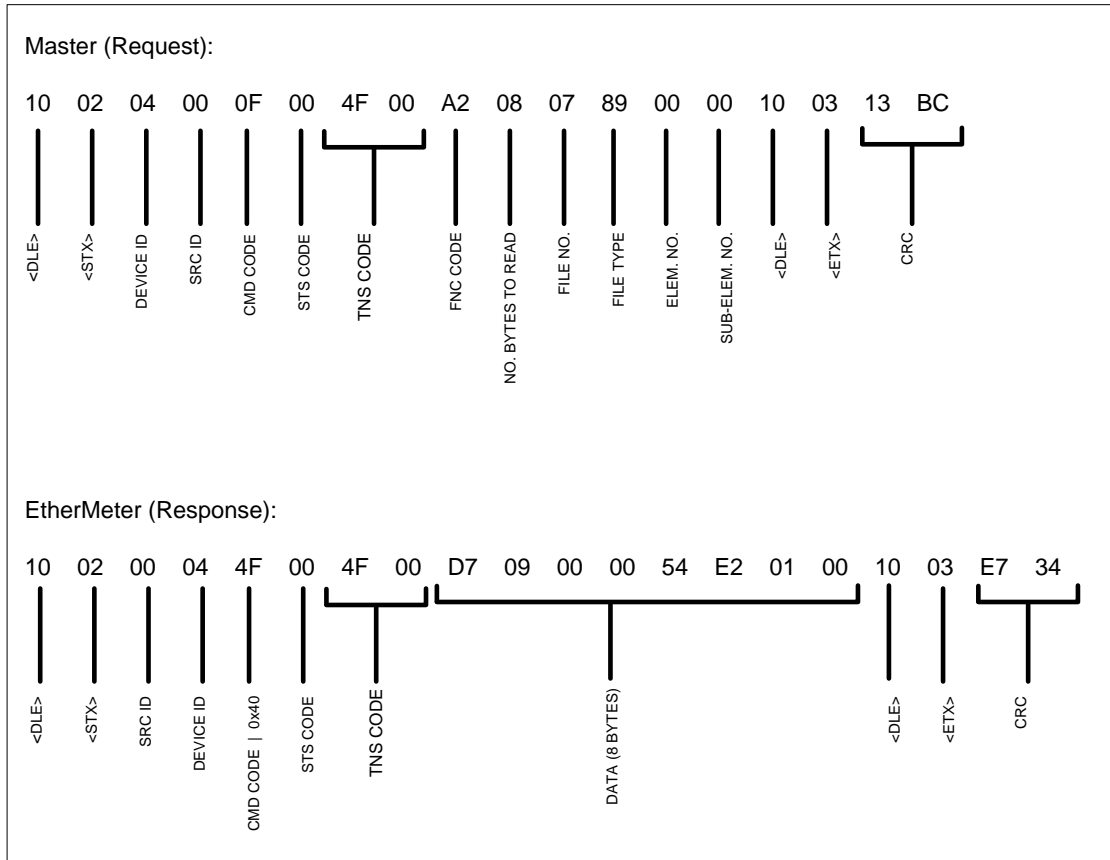

Example DF1-RadioModem Request/Response.

Sample DF1 Commands:

The following samples are provided to familiarize the user with a few of the core DF1 commands. In all samples, the device address=4, and the protocol is DF1-RadioModem. Note that the users' responses will vary in accordance with the unique address and I/O state of each EtherMeter.

**Read: Meter 1, Meter 2, Flow 1, Flow 2
DF1 [CMD,FNC] = [0F,A2]**

Request: 10 02 04 00 0F 00 4F 00 A2 10 10 07 89 00 00 10 03 10 64

Response (example): 10 02 00 04 4F 00 4F 00
 D7 09 00 00 E8 E0 F5 05 00 00 00 00 00 00 00 00
 10 03 3E 85

**Write: Aux Digital Output 1, Aux Digital Output 2 (Turn Outputs 1 and 2 'ON')
DF1 [CMD,FNC] = [0F,AA]**

Request: 10 02 04 00 0F 00 4F 00 AA 02 0A 85 00 00 03 00 10 03 77 33

Response (example): 10 02 00 04 4F 00 4F 00 10 03 25 9C

ETHERNET/IP. The EtherMeter provides elementary support for EtherNet/IP, an industrial communication protocol for Ethernet. EtherNet/IP was originally developed by Rockwell Automation and is now managed by ODVA. This manual assumes that the user is well-versed in the EtherNet/IP Protocol. In order to learn more about this protocol, please visit rockwellautomation.com or odva.org. The following document is a particularly useful reference for EtherNet/IP communications with Rockwell Automation PLC's:

“Communicating With Rockwell Automation Products Using EtherNet/IP Explicit Messaging”
http://www.rockwellautomation.com/enabled/pdf/eipexp1_2.pdf

The EtherMeter implements a functional subset of the EtherNet/IP Protocol:

- “Unconnected Explicit Messaging with Encapsulation of PCCC”
- “Class 3 Connected Explicit Messaging with Encapsulation of PCCC”.

The EtherMeter responds to messages that utilize the following Service Request Codes:

- “Execute PCCC Service” (Code 0x4B)
- “VDH+ Service” (Code 0x4C)
- “Local Service” (Code 0x4D)

Please note that CIP™ and data subscriber/provider mechanisms are not supported; and fragmented EtherNet/IP packets are also not supported.

The EtherNet/IP server is available on TCP logical port 44818 of the EtherMeter, although the user may specify an alternate port through the Setup Menu.

Client Request:
 "Register Session":
 28 Bytes:

```

[65 00] [04 00] [00 00 00 00] [00 00 00 00] [44 69 67 69 45 00 00 00] [00 00 00 00]
[REGISTER SESSION] [LEN OF DATA ATTACHED TO HEADER] [SESSION HANDLE] [STATUS] [CONTEXT] [HEADER OPTIONS]

[01 00] [00 00]
[REGISTER PROTOCOL VERSION] [REGISTER OPTIONS]

```

Server (EtherMeter) Response:
 "Register Session Response"
 28 Bytes:

```

[65 00] [04 00] [05 00 00 00] [00 00 00 00] [44 69 67 69 45 00 00 00] [00 00 00 00]
[REGISTER SESSION] [LEN OF DATA ATTACHED TO HEADER] [SET SESSION HANDLE] [STATUS] [CONTEXT] [HEADER OPTIONS]

[01 00] [00 00]
[REGISTER PROTOCOL VERSION] [REGISTER OPTIONS]

```

Client Request:
 "Execute PCCC Service" Request, Unconnected Read, Encapsulated PCCC.
 Client Requests Registers N7:0-3.
 Totalization From Meter 1 and Meter 2.
 63 Bytes (63 Bytes For Read, 65 Bytes For Write):

```

[6F 00] [27 00] [05 00 00 00] [00 00 00 00] [44 69 67 69 45 00 00 00] [00 00 00 00]
[PCCC OBJECT CODE] [LEN OF DATA ATTACHED TO HEADER] [SESSION HANDLE] [STATUS] [CONTEXT] [HEADER OPTIONS]

[00 00 00 00] [0A 00]
[INTERFACE HANDLE] [TIMEOUT]

[02 00] [00 00 00 00] [B2 00] [17 00]
[MULTIPLIER] [CPF ADDR ITEM] [UCMM] [T-PDU LENGTH (VARIABLE)]

[4B] [02] [20 67 24 01] [07] [25 03] [97 81 3B 9D]
[EXEC PCC SVC] [PATH SIZE] [REQ PATH ] [REQ ID LEN] [VEND ID(DIGI)] [4 LSB'S OF MAC ID]

[0F] [00] [02 00] [A2] [08] [07] [89] [00] [00]
[CMD:TYPED LOGICAL READ W/ 3 ADDR] [STS] [TNS] [FNC] [N. BYTES REQ] [FILE NO.] [INTEGER TYPE] [ELEM.NO.] [SUB-ELEM.NO.]
<----- [PCCC COMMAND] ----->

```

Server (EtherMeter) Response:
 "Execute PCCC Service" Response, Unconnected Read, Encapsulated PCCC.
 Response Contains Registers N7:0-3.
 Totalization From Meter 1 (2519) and Meter 2 (123476).
 63 Bytes (Payload Dependent):

```

[6F 00] [27 00] [05 00 00 00] [00 00 00 00] [44 69 67 69 45 00 00 00] [00 00 00 00]
[PCCC OBJECT CODE] [LEN OF DATA ATTACHED TO HEADER] [SESSION HANDLE] [STATUS] [CONTEXT] [HEADER OPTIONS]

[00 00 00 00] [0A 00]
[INTERFACE HANDLE] [TIMEOUT]

[02 00] [00 00 00 00] [B2 00] [17 00]
[MULTIPLIER] [CPF ADDR ITEM] [UCMM] [T-PDU LENGTH (VARIABLE)]

[CB] [00] [00] [00] [07] [25 03] [97 81 3B 9D]
[EXEC PCC REPLY] [RESERV] [GEN STATUS] [ADDL STATUS SIZE] [REQ ID LEN] [VEND ID(DIGI)] [4 LSB'S OF MAC ID]

[4F] [00] [02 00] [D7 09 00 00 54 E2 01 00]
[CMD:TYPED LOGICAL READ W/ 3 ADDR] [STS] [TNS] [DATA PAYLOAD]
<----- [PCCC COMMAND] ----->

```

Example EtherNet/IP Request/Response (Unconnected Messaging).

```

Client Request:
"Get Attributes All":
46 Bytes:
[5F 00] [16 00] [05 00 00 00] [00 00 00 00] [26 00 00 00 00 00 00] [00 00 00 00]
[SEND RR DATA] [LEN OF DATA ATTACHED TO HEADER] [SESSION HANDLE] [STATUS] [CONTEXT] [HEADER OPTIONS]

[00 00 00 00] [00 00] [02 00] [00 00] [00 00] [B2 00] [06 00]
[INTERFACE HANDLE - CIP] [TIMEOUT] [ITEM COUNT] [NULL ADDRESS ITEM] [LENGTH] [UNCONNECTED DATA ITEM] [LENGTH]

[01] [02] [20 01] [24 01]
[GET ATTRIBUTES ALL] [REQUEST PATH SIZE (WORDS)] [PATH SEGMENT CLASS] [PATH SEGMENT INSTANCE]

Server (EtherMeter) Response:
"Get Attributes All Response"
70 Bytes:
[5F 00] [2D 00] [05 00 00 00] [00 00 00 00] [26 00 00 00 00 00 00] [00 00 00 00]
[SEND RR DATA] [LEN OF DATA ATTACHED TO HEADER] [SESSION HANDLE] [STATUS] [CONTEXT] [HEADER OPTIONS]

[00 00 00 00] [00 00] [02 00] [00 00] [00 00] [B2 00] [ID 00]
[INTERFACE HANDLE - CIP] [TIMEOUT] [ITEM COUNT] [NULL ADDRESS ITEM] [LENGTH] [UNCONNECTED DATA ITEM] [LENGTH]

[81] [00] [00 00] [FF FF] [0C 00] [64 00] [11 0B] [04 00]
[GET ATTRIBUTES ALL RESPONSE] [RESERVED] [STATUS SUCCESS] [VENDOR ID] [DEVICE TYPE] [PRODUCT CODE] [REVISION] [STATUS]

[00 00 00 00] [0A] [45 74 68 65 72 4D 65 74 65 72] [03]
[SERIAL NO - LAST 4 OCTETS MAC ID] [PROD NAME LENGTH] [PRODUCT NAME: EtherMeter] [STATE]

Client Request:
"Register Session":
28 Bytes:
[65 00] [04 00] [00 00 00 00] [00 00 00 00] [44 69 67 69 45 00 00 00] [00 00 00 00]
[REGISTER SESSION] [LEN OF DATA ATTACHED TO HEADER] [SESSION HANDLE] [STATUS] [CONTEXT] [HEADER OPTIONS]

[01 00] [00 00]
[REGISTER PROTOCOL VERSION] [REGISTER OPTIONS]

Server (EtherMeter) Response:
"Register Session Response"
28 Bytes:
[65 00] [04 00] [05 00 00 00] [00 00 00 00] [44 69 67 69 45 00 00 00] [00 00 00 00]
[REGISTER SESSION] [LEN OF DATA ATTACHED TO HEADER] [SET SESSION HANDLE] [STATUS] [CONTEXT] [HEADER OPTIONS]

[01 00] [00 00]
[REGISTER PROTOCOL VERSION] [REGISTER OPTIONS]

Client Request:
"Unconnected Forward Open" Request For Class 3 Connection
86 Bytes (88 Bytes If Conn Path Length = 3 Words):
[5F 00] [3E 00] [05 00 00 00] [00 00 00 00] [C0 A8 01 BF 00 00 01 00] [00 00 00 00]
[PCCC OBJECT CODE] [LEN OF DATA ATTACHED TO HEADER] [SESSION HANDLE] [STATUS] [CONTEXT] [HEADER OPTIONS]

[00 00 00 00] [00 04]
[INTERFACE HANDLE] [TIMEOUT]

[02 00] [00 00] [00 00] [B2 00] [2E 00]
[ITEM COUNT (0x0002)] [ITEM TYPE] [ITEM DATA LENGTH] [UCMM] [T-PDU LENGTH (VARIABLE)]

[54] [02] [20 06 24 01] [0A 0E] [2D 23 82 F2] [EF 22 82 F2]
[FMQ OPEN REQ] [REQ PATH SIZE (WORDS)] [CLASS,CM OBJ,INST] [TIGRS/PRIORITY] [OT-CID] [TO-CID]

[02 10] [01 00] [F6 1D 4F 40] [02] [00 00 00] [C0 C6 2D 00] [02 43]
[CONN S/N] [ORIG VEND ID (ROCKW)] [ORIG S/N] [CONN TIMEOUT MULT] [RESERVED] [OT RPI] [OT PARAMS]

[C0 C6 2D 00] [02 43] [A3] [02] [20 02 24 01]
[TO RPI] [TO PARAMS] [TRANSP CLASS/TRIGGER] [WORDS (16) IN CONN PATH] [CONN PATH]

Server (EtherMeter) Response:
"Unconnected Forward Open" Reply For Class 3 Connection
70 Bytes:
[5F 00] [2E 00] [05 00 00 00] [00 00 00 00] [C0 A8 01 BF 00 00 01 00] [00 00 00 00]
[PCCC OBJECT CODE] [LEN OF DATA ATTACHED TO HEADER] [SESSION HANDLE] [STATUS] [CONTEXT] [HEADER OPTIONS]

[00 00 00 00] [00 04]
[INTERFACE HANDLE] [TIMEOUT]

[02 00] [00 00] [00 00] [B2 00] [1E 00]
[ITEM COUNT (0x0002)] [ITEM TYPE] [ITEM DATA LENGTH] [UCMM] [T-PDU LENGTH (VARIABLE)]

[D4] [00] [00] [00] [6F 32 74 02] [EF 22 82 F2]
[FMQ OPEN RESP] [RESERVED] [GEN STATUS] [SIZE OF ADDL STATUS] [OT-CID] [TO-CID]

[02 10] [01 00] [F6 1D 4F 40] [20 FD 4B 00] [20 FD 4B 00] [00] [00]
[CONN S/N] [ORIG VEND ID] [ORIG S/N] [OT API] [TO API] [SIZE OF APP REPLY] [RESERVED]

Client Request:
"Execute PCCC Service" Request, Send Unit Data, Encapsulated PCCC.
Client Requests Registers N7.0-7.
Totalization And Flow From Meter 1 and Meter 2.
69 Bytes (69 For Read, 71 For Write):
[70 00] [2D 00] [05 00 00 00] [00 00 00 00] [C0 A8 01 BF 00 00 01 01] [00 00 00 00]
[SEND UNIT DATA T3 CONN MSG] [LEN OF DATA ATTACHED TO HEADER] [SESSION HANDLE] [STATUS] [CONTEXT] [HEADER OPTIONS]

[00 00 00 00] [0A 00]
[INTERFACE HANDLE] [TIMEOUT]

[02 00] [A1 00] [04 00] [6F 32 74 02] [B1 00] [19 00]
[ITEM COUNT (0x0002)] [CONN ADDR ITEM (0x00A1)] [CID LENGTH] [OT-CID] [CONNECTED DATA ITEM] [T-PDU LENGTH (VARIABLE)]

[01 00] [4B] [02] [20 67 24 01] [07] [01 00] [F6 1D 4F 40]
[REQUESTOR] [EXEC PCCC SVC] [PATH SIZE (WORDS)] [CLASS PCCC,INSTANCE 1] [REQ ID LEN] [VEND ID (ROCKW)] [ORIG S/N]

[0E] [00] [01 00] [A2] [10] [07] [89] [00] [00]
[CMD: TYPED LOGICAL READ W/ 3 ADDR] [SRS] [SNS] [FNC] [N BYTES REQ] [FILE NO.] [INTEGER TYPE] [ELEM. NO.] [SUB-ELEM. NO.]
<----- [PCCC COMMAND] ----->

Server (EtherMeter) Response:
"Execute PCCC Service" Response, Send Unit Data, Encapsulated PCCC.
Response Contains Registers N7.0-7.
Totalization And Flow From Meter 1 (2519) and Meter 2 (123476).
77 Bytes (Payload Dependent):
[70 00] [35 00] [05 00 00 00] [00 00 00 00] [C0 A8 01 BF 00 00 01 01] [00 00 00 00]
[SEND UNIT DATA T3 CONN MSG] [LEN OF DATA ATTACHED TO HEADER] [SESSION HANDLE] [STATUS] [CONTEXT] [HEADER OPTIONS]

[00 00 00 00] [0A 00]
[INTERFACE HANDLE] [TIMEOUT]

[02 00] [A1 00] [04 00] [6F 32 82 F2] [B1 00] [21 00]
[ITEM COUNT (0x0002)] [CONN ADDR ITEM (0x00A1)] [CID LENGTH] [TO-CID] [CONNECTED DATA ITEM] [T-PDU LENGTH (VARIABLE)]

[01 00] [CB] [00] [00] [00] [07] [01 00] [F6 1D 4F 40]
[REQUESTOR] [EXEC PCCC REPLY] [RESERV] [GEN STATUS] [ADDL STATUS SIZE] [REQ ID LEN] [VEND ID (ROCKW)] [S/N]

[4F] [00] [01 00] [00 00 13 00 F5 05 F8 ED 00 00 00 00 00 00]
[CMD: TYPED LOGICAL READ W/ 3 ADDR] [SRS] [SNS] [DATA PAYLOAD]
<----- [PCCC COMMAND] ----->

```

Example EtherNet/IP Request/Response (Class 3 Connected Messaging).

TOTALIZATION AND FLOW DATA FORMAT:

The EtherMeter was designed in such a way as to simplify and compress the formatting of all reported data. As shown in the previous charts, no floating point or 64-bit registers are implemented in the N7 registers, as all data is represented internally as 32-bit long integers (signed or unsigned) and 16-bit signed integers.

In order to achieve a high level of simplicity and prevent integer overflows, separate exponential scale factors and multipliers are provided in certain N7 registers.

If fully-scaled totalization data is desired, then 64-bit data processing may be required by the DF1 master polling PLC or computer. In most instances, however, 32-bit data manipulation will suffice.

TOTALIZATION HELPER FORMULAS:

The following calculations are examples helper formulas that may be implemented within the master. When deciding whether to use 64-bit versus 32-bit data manipulation routines at the master, it is recommended that the user factor in the largest expected meter totalization value (meter-specific), and consider that the largest possible 32-bit unsigned long integer is 4,294,967,295.

$$\begin{aligned} \text{Meter 1 Actual Total} &= ([\text{METER 1 TOTAL UNSCALED}] \times [10^{[\text{METER 1 EXPONENT}]}]) \\ &\quad + ([\text{ROLLOVERS METER 1}] \times [10^{[\text{METER 1 nDIGITS}]}] \times [10^{[\text{METER 1 EXPONENT}]}]) \\ &= ([N7:0,1] \times [10^{[N7:20]}]) + ([N7:8] \times [10^{[N7:18]}] \times [10^{[N7:20]}]) \end{aligned}$$

$$\begin{aligned} \text{Meter 2 Actual Total} &= ([\text{METER 2 TOTAL UNSCALED}] \times [10^{[\text{METER 2 EXPONENT}]}]) \\ &\quad + ([\text{ROLLOVERS METER 2}] \times [10^{[\text{METER 2 nDIGITS}]}] \times [10^{[\text{METER 2 EXPONENT}]}]) \\ &= ([N7:2,3] \times [10^{[N7:21]}]) + ([N7:9] \times [10^{[N7:19]}] \times [10^{[N7:21]}]) \end{aligned}$$

FLOW RATE HELPER FORMULAS:

The following are possible flow rate helper formulas that may be implemented within a DF1 master polling PLC or computer:

$$\begin{aligned} \text{Meter 1 Actual Flow} &= [\text{FLOW 1}] / 1000 \\ &= [N7:4,5] / 1000 \end{aligned}$$

$$\begin{aligned} \text{Meter 2 Actual Flow} &= [\text{FLOW 2}] / 1000 \\ &= [N7:6,7] / 1000 \end{aligned}$$

EXAMPLE:

Consider the following case of a meter register installed on meter channel 1. This register contains 8 variable digits plus two (2) fixed zeros on the right. (EXP1=+2.)

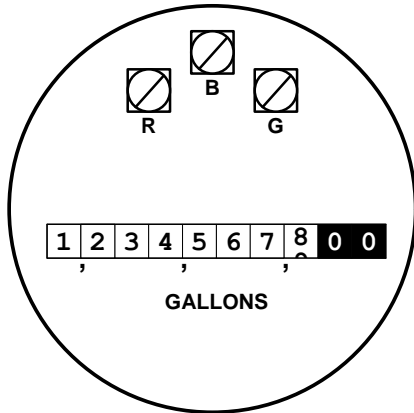

In this case, the actual total is 1,234,567,800 gallons. However, the [N7:0,1] register will report the total as: 12,345,678. If scaling to GALLONS is desired, then the polling device (master) must perform the scaling (multiply by $10^{(EXPn)}$ or $10^{[N7:21]}$ or 100).

Regarding flow, all reported flow rates are multiplied by 1000 to eliminate the need for floating point formatting within the EtherMeter. In this case, if the actual flow rate is 987.6 GPM, then the [N7:4,5] register will report the flow as 987,600 (milliGallons/minute). If scaling to GPM is desired, then the polling device (master) must perform the floating point conversion and scaling (divide by 1000).

On the LCD display and within the Allen Bradley flow registers, the following table displays the flow units that pertain to the totalization units:

Totalization Units	Flow Units	N-Register Values (N7:22, N7:23)
Gallons	Gallons Per [Hour,Minute,Sec]	0
Liters	Liters Per [Hour,Minute,Sec]	1
Cubic Feet	Cubic Feet Per [Hour,Minute,Sec]	2
Cubic Meters	Cubic Meters Per [Hour,Minute,Sec]	3
Pounds	Pounds Per [Hour,Minute,Sec]	4
Kilograms	Kilograms Per [Hour,Minute,Sec]	5
Acre Feet	Gallons Per [Hour,Minute,Sec]	6
Units	Units Per [Hour,Minute,Sec]	7

Figure 15A. Totalizer Unit N-Register Codes

16 ADAM-4000 PROTOCOL SUPPORT

The EtherMeter is available with ADAM-4000 protocol support (Special: ADAM Version Only). This portion of the manual assumes that the user is well-versed in the ADAM-4000 Protocol. In order to learn more about the ADAM-4000 protocol, visit www.advantech.com.

The following subset of the ADAM-4000 protocol is supported by the EtherMeter:

#AAAn	- Read Analog Inputs (32 bit signed hexadecimal format)
\$AA6	- Read Discrete Inputs
#AA100d	- Write Discrete Outputs
\$AAM	- Read Device ID

The checksum option is available, but turned OFF by default. Checksum may be enabled via the Setup Menu.

To test and/or verify ADAM-4000 communications with the EtherMeter, a terminal program (such as "HyperTerminal", "PuTTY", or "Tera Term") may be used.



Figure 16A.

The ADAM-4080D 2-Channel Pulse Counter Input Module is often used to interface to pulse-output meter registers. As an improvement, the EtherMeter may be used as an ADAM-compatible replacement for interfacing to encoder-output meter registers.

FUNCTION: #AA_n (READ ANALOG INPUTS)*

<u>REGISTERS (Hex)</u>	<u>DESCRIPTORS</u>
0	METER 1 TOTAL (UNSCALED)
1	METER 2 TOTAL (UNSCALED)
2	FLOW 1 X 1000
3	FLOW 2 X 1000
4	ROLLOVERS – METER 1
5	ROLLOVERS – METER 2
6	AIN 1 (0-10000)
7	AIN 2 (0-10000)
8	SUPPLY VOLTS X 10
9	DIGITAL STATUS BITS
A	METER 1 READ FAULT
B	METER 2 READ FAULT
C	SYSTEM UPTIME (MINUTES)

*AA : HEX DEVICE ADDRESS
n : HEX INPUT CHANNEL (0-F)

FUNCTION: \$AA6 (READ DISCRETE INPUTS)*

<u>INPUTS</u>	<u>DESCRIPTORS</u>
0	AUXILIARY DIGITAL I/O 1
1	AUXILIARY DIGITAL I/O 2
2	AUXILIARY DIGITAL I/O 3
3	-reserved/future-
4	-reserved/future-
5	-reserved/future-
6	METER 1 READ FAULT
7	METER 2 READ FAULT

*AA : HEX DEVICE ADDRESS

FUNCTION: #AA1_n0_d (WRITE RELAY)*

<u>COILS</u>	<u>DESCRIPTOR</u>
0	AUXILIARY DIGITAL OUTPUT 1
1	AUXILIARY DIGITAL OUTPUT 2
2	AUXILIARY DIGITAL OUTPUT 3
3	REBOOT DEVICE
4-7	-reserved/future-
8	RESET CNT1 to ZERO (When Meter Ch. 1 Pulse Input)
9	RESET CNT2 to ZERO (When Meter Ch. 2 Pulse Input)
A-F	-reserved/future-

*AA : HEX DEVICE ADDRESS
n : HEX COIL ADDRESS (0-F)
d : 1 (ON) or 2 (OFF)

FUNCTION: \$AAM (READ DEVICE ID)*

RESPONSE: !AAETHERMETER<CR>

*AA : HEX DEVICE ADDRESS

ADAM Analog Register 9 contains the 16-bit word: "Digital Status Bits". The contents of this word are as illustrated in the following table:

Bit Position	Contents
00 (Least Significant Bit)	Aux Digital I/O 1 Status (1=ON, 0=OFF)
01	Aux Digital I/O 2 Status (1=ON, 0=OFF)
02	Aux Digital I/O 3 Status (1=ON, 0=OFF)
03	-reserved/future-
04	-reserved/future-
05	-reserved/future-
06	-reserved/future-
07	-reserved/future-
08	Meter 1 Read Fault (1=Fault, 0=OK)
09	Meter 2 Read Fault (1=Fault, 0=OK)
10	Meter 1 Fwd Flow (1=Fwd Flow)
11	Meter 2 Fwd Flow (1=Fwd Flow)
12	Meter 1 Rev Flow (1=Rev Flow)
13	Meter 2 Rev Flow (1=Rev Flow)
14	-reserved/future-
15 (Most Significant Bit)	-reserved/future-

For example, if **Analog Register 9** contains the following:

0000 1100 0000 0111 (Binary)... or 0C07 (Hexadecimal)... or 3079 (Decimal)

Then the following status conditions exist:

Aux Digital I/O 1	1	ON
Aux Digital I/O 2	1	ON
Aux Digital I/O 3	1	ON
-N/A-	0	-N/A-
-N/A-	0	-N/A-
-N/A-	0	-N/A-
-N/A-	0	-N/A-
-N/A-	0	-N/A-
Meter 1 Read Fault	0	OFF (OK)
Meter 2 Read Fault	0	OFF (OK)
Meter 1 Fwd Flow	1	ON
Meter 2 Fwd Flow	1	ON
Meter 1 Rev Flow	0	OFF
Meter 2 Rev Flow	0	OFF
-N/A-	0	-N/A-
-N/A-	0	-N/A-

Master (Request):

04 0 <CR>

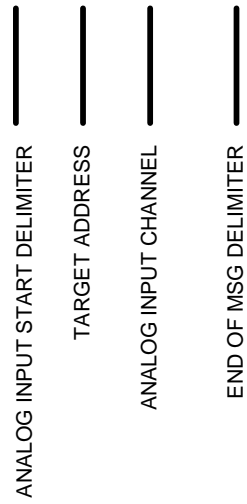

EtherMeter (Response):

> 5 F 5 E 0 F 3 <CR>

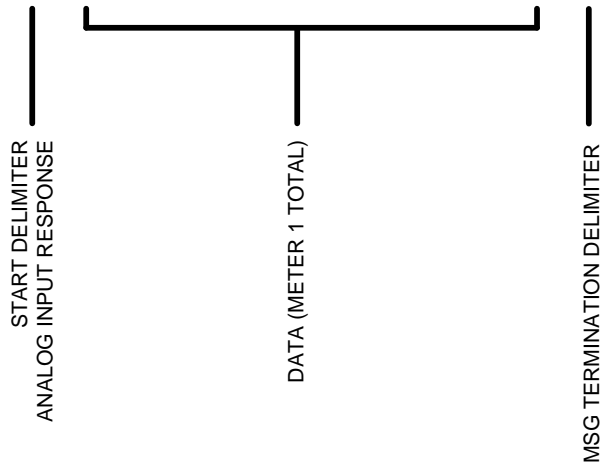

Example ADAM-4000 Request/Response.

Note the response, 5F5E0F3 hexadecimal, which corresponds to 99999987 decimal. Note that all ADAM analog data is transmitted in hexadecimal format.

TOTALIZATION AND FLOW DATA FORMAT:

The EtherMeter was designed in such a way as to simplify and compress the formatting of all reported data. As shown in the previous charts, no floating point or 64-bit registers are implemented in the ADAM-4000 holding registers, as all data is represented internally as 32-bit long integers (signed or unsigned) and 16-bit signed integers.

In order to achieve a high level of simplicity and prevent integer overflows, separate exponential scale factors and multipliers are provided in certain ADAM-4000 registers.

If fully-scaled totalization data is desired, then 64-bit data processing may be required by the master polling PLC or computer. In most instances, however, 32-bit data manipulation will suffice.

TOTALIZATION HELPER FORMULAS:

The following calculations are examples helper formulas that may be implemented within the master. When deciding whether to use 64-bit versus 32-bit data manipulation routines, factor in the largest expected meter totalization value (meter-specific), and consider that the largest possible 32-bit unsigned long integer is 4,294,967,295.

$$\begin{aligned} \text{Meter 1 Actual Total} &= ([\text{METER 1 TOTAL UNSCALED}] \times [10^{[\text{METER 1 EXPONENT}]}]) \\ &+ ([\text{ROLLOVERS METER 1}] \times [10^{[\text{METER 1 nDIGITS}]}] \times [10^{[\text{METER 1 EXPONENT}]}]) \\ &= ([\text{ADAM-0x00}] \times [10^{[\text{EXP1}]}]) \\ &+ ([\text{ADAM-0x04}] \times [10^{[\text{NDIGITS METER 1}]}] \times [10^{[\text{EXP1}]}]) \end{aligned}$$

$$\begin{aligned} \text{Meter 2 Actual Total} &= ([\text{METER 2 TOTAL UNSCALED}] \times [10^{[\text{METER 2 EXPONENT}]}]) \\ &+ ([\text{ROLLOVERS METER 2}] \times [10^{[\text{METER 2 nDIGITS}]}] \times [10^{[\text{METER 2 EXPONENT}]}]) \\ &= ([\text{ADAM-0x01}] \times [10^{[\text{EXP2}]}]) \\ &+ ([\text{ADAM-0x05}] \times [10^{[\text{NDIGITS METER 2}]}] \times [10^{[\text{EXP2}]}]) \end{aligned}$$

FLOW RATE HELPER FORMULAS:

The following are possible flow rate helper formulas that may be implemented within a MODBUS master polling PLC or computer:

$$\begin{aligned} \text{Meter 1 Actual Flow} &= [\text{FLOW 1}] / 1000 \\ &= [\text{ADAM-0x02}] / 1000 \end{aligned}$$

$$\begin{aligned} \text{Meter 2 Actual Flow} &= [\text{FLOW 2}] / 1000 \\ &= [\text{ADAM-0x03}] / 1000 \end{aligned}$$

EXAMPLE:

Consider the following case of a meter register installed on meter channel 1. This register contains 8 variable digits plus two (2) fixed zeros on the right. (EXP1=+2.)

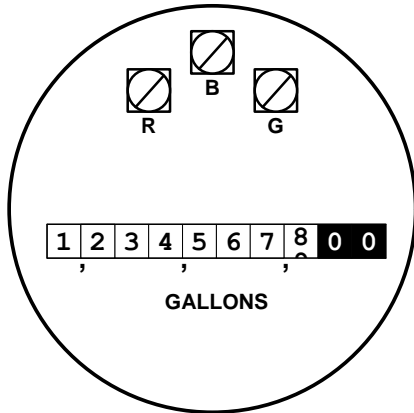

In this case, the actual total is 1,234,567,800 gallons. However, the [0x00] ADAM-4000 holding register will report the total as: 12,345,678. If scaling to GALLONS is desired, then the polling device (master) must perform the scaling (multiply by $10^{(EXPn)}$ or 100).

Regarding flow, all reported flow rates are multiplied by 1000 to eliminate the need for floating point formatting within the EtherMeter. In this case, if the actual flow rate is 987.6 GPM, then the [0x02] ADAM-4000 holding register will report the flow as 987,600 (milliGallons/minute). If scaling to GPM is desired, then the polling device (master) must perform the floating point conversion and scaling (divide by 1000).

Also, keep in mind that the EtherMeter reports all ADAM-4000 analog data in hexadecimal ASCII format.

On the LCD display and within the ADAM flow registers, the following table displays the flow units that pertain to the totalization units:

Totalization Units	Flow Units
Gallons	Gallons Per [Hour,Minute,Sec]
Cubic Feet	Cubic Feet Per [Hour,Minute,Sec]
Liters	Liters Per [Hour,Minute,Sec]
Cubic Meters	Cubic Meters Per [Hour,Minute,Sec]
Pounds	Pounds Per [Hour,Minute,Sec]
Kilograms	Kilograms Per [Hour,Minute,Sec]
Acre Feet	Gallons Per [Hour,Minute,Sec]
Units	Units Per [Hour,Minute,Sec]

17 ASCII PROTOCOL SUPPORT

The EtherMeter is available with RAW-ASCII protocol support (Optional. ASCII-Version Only).

Many PLC's and RTU's are equipped with extra serial ports that are capable of collecting data from raw ASCII terminal devices such as bar code readers. For compatibility with these PLC's, the EtherMeter provides a "Raw ASCII Protocol" output.

When the EtherMeter is set to "Raw ASCII" mode (available via the Setup Menu), the following data is transmitted from the active serial port every three (3) seconds:

```
: <TOTAL1> ; <TOTAL2> ; <FLOW1> ; <FLOW2> ; <ROLLOVERS1> ; <ROLLOVERS2> ;  
<METER_FAULT1> ; <METER_FAULT2> ; <ANALOG_IN1> ; <ANALOG_IN2> ;  
<AUX_DIGITAL_IO_1> ; <AUX_DIGITAL_IO_2> ; <AUX_DIGITAL_IO_3> <CR> <LF>
```

Each transmission is preceded by a ':' delimiter, and ended with a <CR><LF> delimiter. There are no spaces or carriage returns between the data fields, as each field is separated by a ';' delimiter.

TOTALIZATION AND FLOW DATA FORMAT:

The EtherMeter was designed in such a way as to simplify and compress the formatting of all reported data. In order to achieve this level of simplicity, the scale factors (EXP1 and EXP2) have been stripped from the reported totals (Note: the 2x16 LCD display and web page provide scaled displays).

For example, consider the following case of an 8-digit register plus two (2) fixed zeros on the right (EXPn=+2):

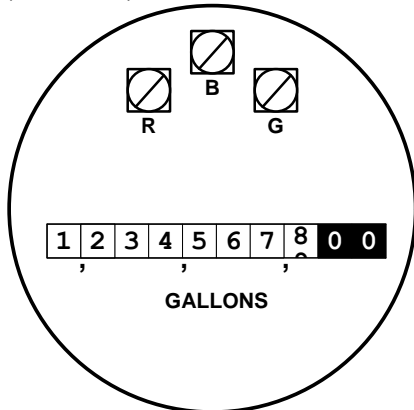

In this case, the actual total is 1,234,567,800 gallons. However, the ASCII protocol will report the total as: 12345678. If scaling to GALLONS is desired, then the reading device must perform the scaling (multiply by 100).

Regarding flow, all reported flow rates are multiplied by 1000 to eliminate the need for floating point formatting. In this case, if the actual flow rate is 987.6 GPM, then the ASCII protocol will report the flow as 987600 (MilliGallons Per Minute). If scaling to GPM is desired, then the reading device must perform the scaling (divide by 1000). Also, keep in mind that all reported ASCII data is formatted in decimal.

On the LCD display and within the ASCII flow fields, the following table displays the flow units that pertain to the totalization units:

Totalization Units	Flow Units
Gallons	Gallons Per [Hour,Minute,Sec]
Cubic Feet	Cubic Feet Per [Hour,Minute,Sec]
Liters	Liters Per [Hour,Minute,Sec]
Cubic Meters	Cubic Meters Per [Hour,Minute,Sec]
Pounds	Pounds Per [Hour,Minute,Sec]
Kilograms	Kilograms Per [Hour,Minute,Sec]
Acre Feet	Gallons Per [Hour,Minute,Sec]
Units	Units Per [Hour,Minute,Sec]

18 SERIAL DISPLAY PROTOCOL SUPPORT

The EtherMeter is available with Remote Serial Display protocol support (Special: VFDisplay-Version Only). When utilized in this mode, the EtherMeter may be used to drive an economical remote serial display, such as the VFD-420 Vacuum Fluorescent Display by SEETRON (Scott Edwards Electronics, www.seetron.com).



Figure 18A. The VFD-420 Vacuum Fluorescent Display, Manufactured By SEETRON.

The “Serial Display” Protocol is similar to the “Raw ASCII” protocol, except that textual descriptions are transmitted along with the data, and screen position control codes are transmitted so as to format the display.

The following screens are displayed in a repeating rotation:

Displayed Data	On-Screen Duration (Seconds)
Meter 1 Total	3
Meter 2 Total	3
Meter 1 Flow	3
Meter 2 Flow	3
Supply Voltage (Volts)	1.5
Analog Input #1 (0-100%)	1.5
Analog Input #2 (0-100%)	1.5
Aux Digital I/O 1 Status (ON/OFF)	1.5
Aux Digital I/O 2 Status (ON/OFF)	1.5
Aux Digital I/O 2 Status (ON/OFF)	1.5
Active Serial Protocol	1.5
Device Address	1.5
Device Uptime (minutes)	1.5
Firmware Version	1.5
User-Defined Banner Text	3

Note that any of the above screens may be disabled (skipped) through the Setup Menu.

Mounting Dimensions:

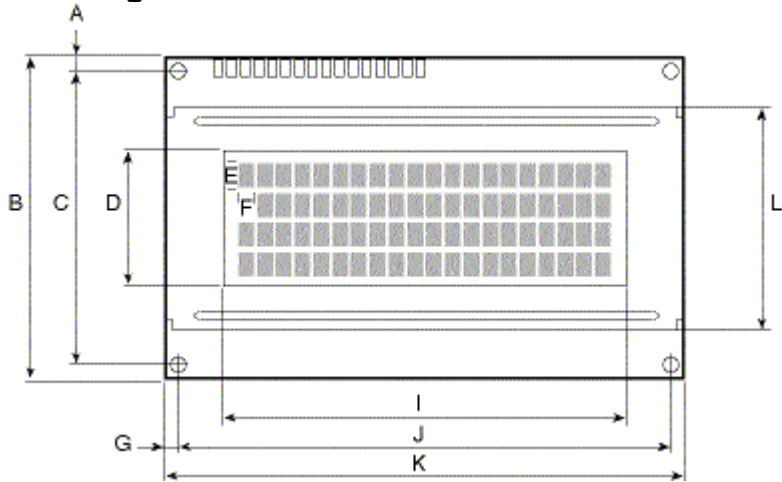

A	y offset edge to hole center (top & bottom)	2.50
B	y pcb height	60.00
C	y hole spacing (inside pair)	55.00
D	y screen opening	20.90
E	y character size	4.70
F	x character size	2.40
G	x offset pcb edge to hole center	2.50
H	x screen frame	N/A
I	x screen opening	70.80
J	x hole spacing	93.00
K	x pcb width	98.00
L	y frame height	N/A
-	mounting hole diameter	2.50
-	frame depth	14.00

All dimensions in millimeters. Tolerance is +/- 0.50mm.
Maximum depth (front of screen to highest point on pcb) is 26mm.

Figure 18A. VFD420 Dimensions

Notes:

1. A separate 5VDC (500mA) power supply is required for the display.
2. The display may be mounted to the front door of a small enclosure.
A rectangular panel punch may be required.
For the SEETRON VFD420 Display, the following Greenlee punch is recommended:

P/N 60062
Hole Size 1.378 X 3.228in. (35.0 X 82.0mm)

3. SCADAmetrics offers an outdoor-grade Lexan® bezel kit, which provides a wider, waterproof adhesive band than the similar model offered by SEETRON:

SCADAMETRICS P/N: EBEZ-420.

4. When used, a serial display monopolizes the serial port. However, simultaneous MODBUS/TCP/UDP capability is operational by default.
5. SEETRON links are provided in Section 17 "References".

EtherMeter-to-Serial Display Wiring Diagram:

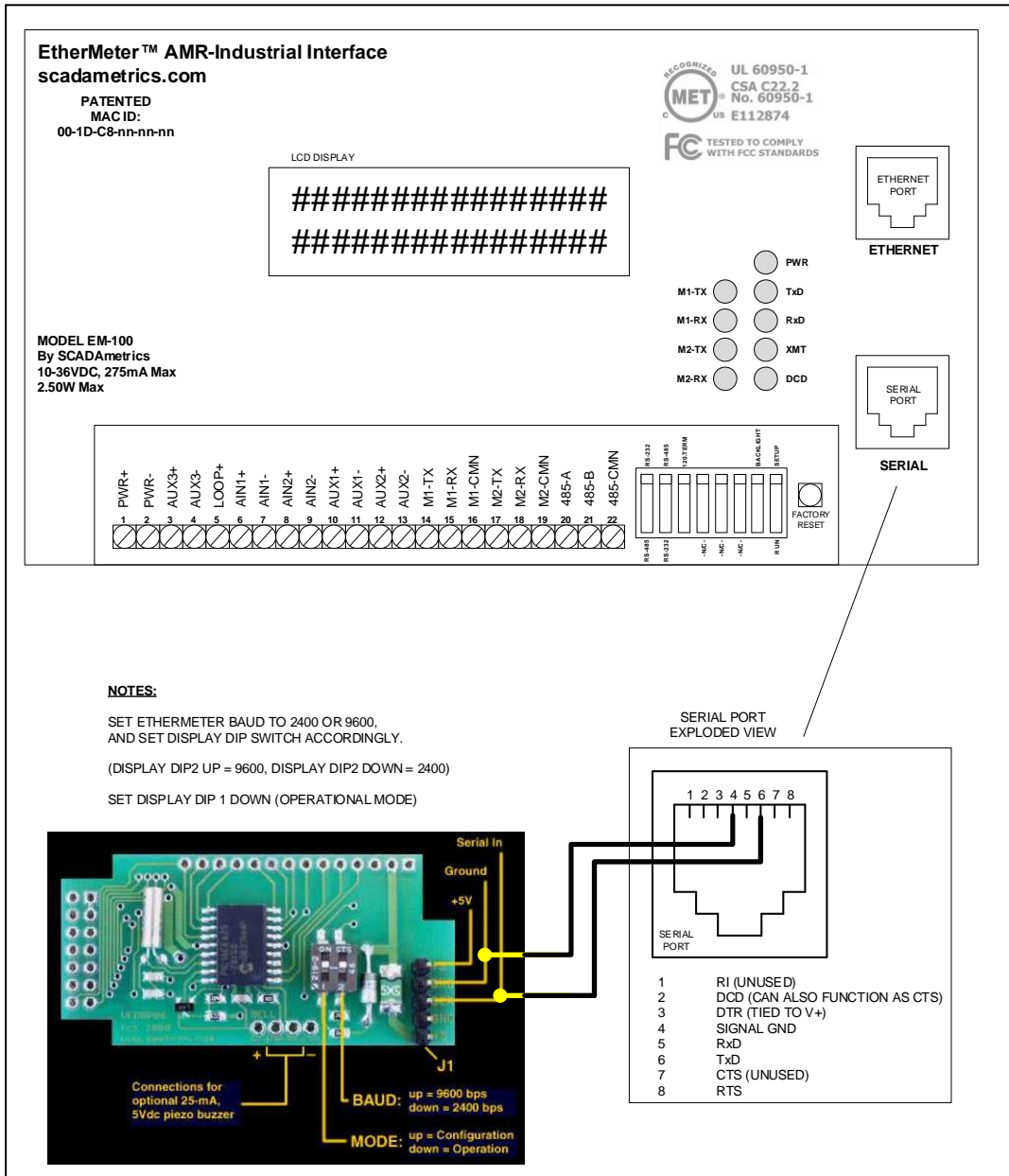

19 HTTP WEB SERVER

The EtherMeter offers an integral web server, which is active on TCP logical port 80. The device also features a “Ping Server”, which is useful for locating and troubleshooting the EtherMeter on a network. Note that both static IP and dynamic IP (DHCP) addressing is supported. (Static or Dynamic IP Address selection is made in the Setup Menu.) The unique MAC ID of each EtherMeter is printed on the front cover of the unit.

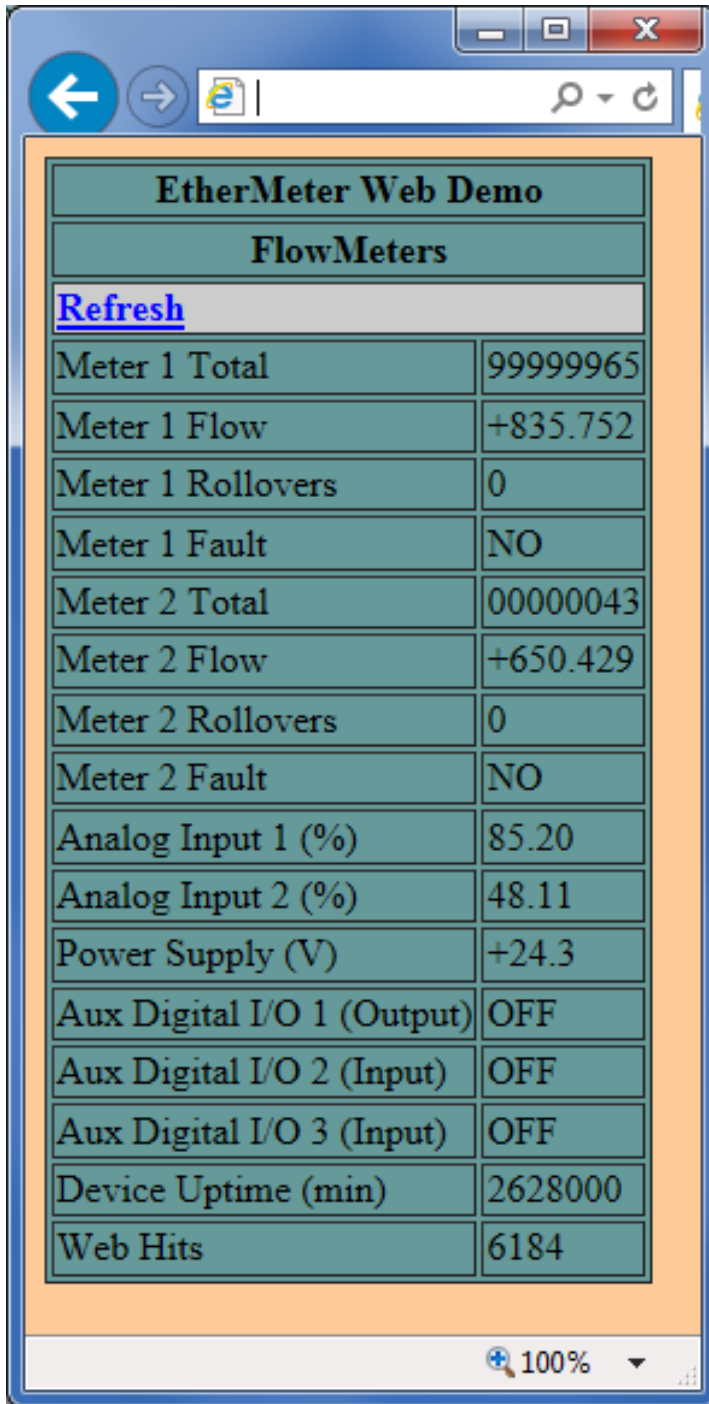

The screenshot shows a web browser window displaying the 'EtherMeter Web Demo' page. The page has a title bar with standard window controls and a navigation bar with back, forward, and search icons. The main content area is titled 'EtherMeter Web Demo' and 'FlowMeters'. Below the title is a 'Refresh' link. The data is presented in a table with two columns: the metric name and its value.

EtherMeter Web Demo	
FlowMeters	
Refresh	
Meter 1 Total	99999965
Meter 1 Flow	+835.752
Meter 1 Rollovers	0
Meter 1 Fault	NO
Meter 2 Total	00000043
Meter 2 Flow	+650.429
Meter 2 Rollovers	0
Meter 2 Fault	NO
Analog Input 1 (%)	85.20
Analog Input 2 (%)	48.11
Power Supply (V)	+24.3
Aux Digital I/O 1 (Output)	OFF
Aux Digital I/O 2 (Input)	OFF
Aux Digital I/O 3 (Input)	OFF
Device Uptime (min)	2628000
Web Hits	6184

The browser's status bar at the bottom shows a zoom level of 100%.

Figure 19A.
A Screen Image of a page served by the EtherMeter Web Server.

The following web page is served by the EtherMeter:

`/index.html` A single-frame web page containing a snapshot of the data.

Through the use of an off-board web server, customized, frame-based web pages may be developed for displaying data from multiple installed EtherMeters™.

The following web page is a simple example:

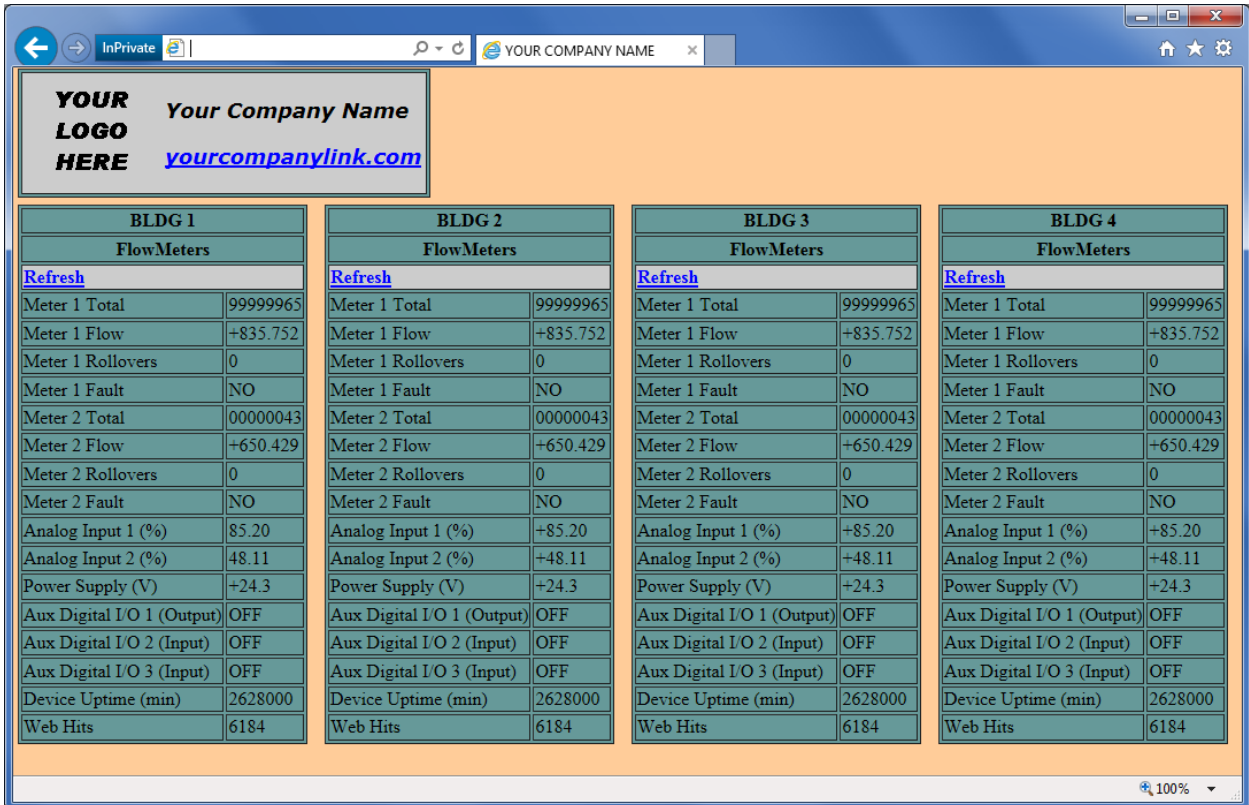

Figure 19B. Sample Customized Frame-Based Web Page

Source HTML:

```
<!DOCTYPE html PUBLIC "-//W3C//DTD XHTML 1.0 Frameset//EN" "DTD/xhtml1-frameset.dtd">
<html xmlns="http://www.w3.org/1999/xhtml" xml:lang="en" lang="en">

<head>
<meta content="text/html; charset=utf-8" http-equiv="Content-Type" />
<title>Your Company Name Here</title>
</head>

<frameset rows="118,*" framespacing="0" frameborder="0">
<frame src="yourfile.html" marginheight="1" marginwidth="4">
<frameset cols="25%,25%,25%,25%">
<frame src="http://192.168.1.140/index.html" marginheight="1" marginwidth="4" />
<frame src="http://192.168.1.141/index.html" marginheight="1" marginwidth="4" />
<frame src="http://192.168.1.142/index.html" marginheight="1" marginwidth="4" />
<frame src="http://192.168.1.143/index.html" marginheight="1" marginwidth="4" />
</frameset>
</frameset>

</html>
```

Figure 19C. Sample Customized Frame-Based HTML Code

20 TELNET SERVER

The EtherMeter provides a basic integrated TELNET server. With the use of TELNET client software, the user may log in to the EtherMeter from a remote node on the network to perform setup and maintenance tasks. However, only one (1) remote user may TELNET to the EtherMeter at any given time.

Windows® TELNET (bundled with Microsoft® Windows®) and HyperTerminal Private Edition™ (By Hilgraeve) are the recommended and supported TELNET clients.

To initiate a TELNET session, the user should specify the IP address of the EtherMeter and the TELNET TCP Port (23). Once connected, a login prompt will appear.

Username: **emeter** (case-insensitive. May not be changed.)
Password: **emeter** (case-insensitive. May be changed through the Setup Menu.)

Once logged in, the user has full access to the Setup Menu. (See Chapter 11 for details.) After the desired maintenance tasks are completed, the user may log out by typing the following command at the prompt: **logout**

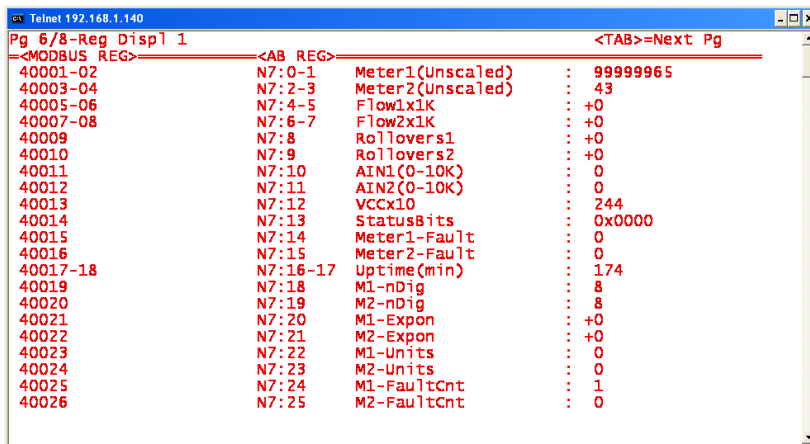

```
Telnet 192.168.1.140
Pg 6/8-Reg Displ 1
<MODBUS REG> <AB REG> <TAB>=Next Pg
40001-02 N7:0-1 Meter1(Unscaled) : 99999965
40003-04 N7:2-3 Meter2(Unscaled) : 43
40005-06 N7:4-5 Flow1x1K : +0
40007-08 N7:6-7 Flow2x1K : +0
40009 N7:8 Rollovers1 : +0
40010 N7:9 Rollovers2 : +0
40011 N7:10 AIN1(0-10K) : 0
40012 N7:11 AIN2(0-10K) : 0
40013 N7:12 VCCx10 : 244
40014 N7:13 StatusBits : 0x0000
40015 N7:14 Meter1-Fault : 0
40016 N7:15 Meter2-Fault : 0
40017-18 N7:16-17 Uptime(min) : 174
40019 N7:18 M1-nDig : 8
40020 N7:19 M2-nDig : 8
40021 N7:20 M1-Expon : +0
40022 N7:21 M2-Expon : +0
40023 N7:22 M1-Units : 0
40024 N7:23 M2-Units : 0
40025 N7:24 M1-FaultCnt : 1
40026 N7:25 M2-FaultCnt : 0
```

Figure 20A. Screen Image of a Microsoft® Windows® TELNET Client Session.

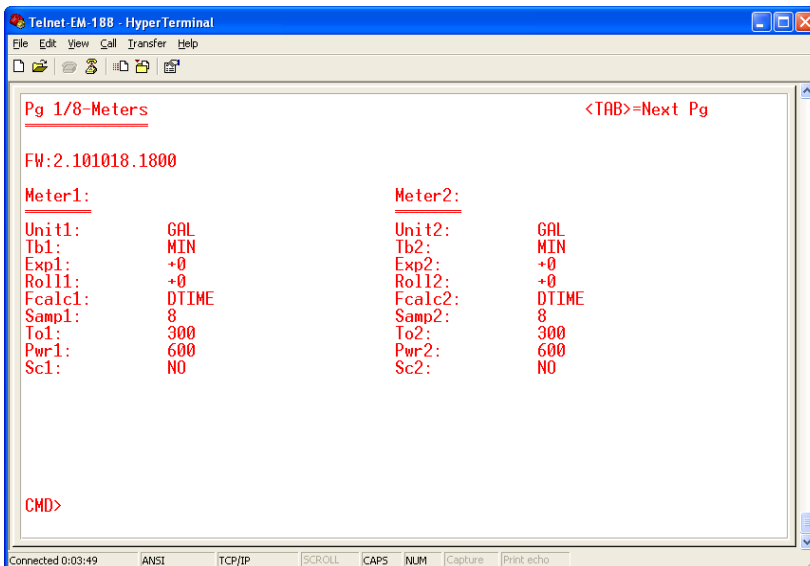

```
Telnet-EM-188 - HyperTerminal
Pg 1/8-Meters <TAB>=Next Pg
FW:2.101018.1800
Meter1: Meter2:
Unit1: GAL Unit2: GAL
Tb1: MIN Tb2: MIN
Exp1: +0 Exp2: +0
Roll1: +0 Roll2: +0
Fcalc1: DTIME Fcalc2: DTIME
Samp1: 8 Samp2: 8
To1: 300 To2: 300
Pwr1: 600 Pwr2: 600
Sc1: NO Sc2: NO
CMD>
```

Figure 20B. Screen Image of a HyperTerminal Private Edition™ TELNET Client Session.

21 **NETWORK SECURITY**

The networking capabilities of the EtherMeter are very basic. Therefore, the device is not designed to be staged at network locations where it would be exposed to Internet threats.

When an EtherMeter is installed within an industrial network that features a Gateway to the Internet, a firewall should be properly installed and configured to shield the EtherMeter, as well as all other industrial controls, from the vagaries of unfiltered Internet traffic.

22 REFERENCES

METERS:

ABB. AquaMaster Mag-Meter:
<http://abb.com/>

Badger. HRE, ADE, and MagMeter Registers:
<http://badgermeter.com/>

Honeywell / Elster AMCO (ABB/Kent). InVision and ScanCoder Registers, evoQ4 Mag-Meter:
<http://www.elsteramcowater.com/>

Hersey/Mueller. Translator Register:
<http://www.muellersystems.com/>

Master Meter. Acculinx Register and Elinx Register:
<http://mastermeter.com/>

McCrometer Meter. "Smart Output" Registers:
<http://mccrometer.com>

Metron Farnier. HawkeyeOER Register, Innov8 Register:
<http://metronfarnier.com/>

Neptune (Schlumberger). E-Coder, ProCoder, and ProRead Registers:
<http://neptunetq.com/>

RG3 Meter. Tomahawk Register:
<http://rg3meter.com/>

Sensus (Rockwell/Invensys). OMNI, iPerl, ICE, and ECR Registers:
<http://www.sensus.com/>

Siemens (Sitrans). F M MAG 8000 Mag-Meter:
<http://www.siemens.com/>

Zenner USA Meter. ETR (Encoder Type Register):
<http://zennerusa.com>

INDUSTRIAL COMMUNICATION PROTOCOLS:

Official MODBUS-IDA Consortium:
<http://modbus.org>

MODBUS Protocol Specification:
http://modbus.org/docs/PI_MBUS_300.pdf

DF1 Protocol Specification:
http://literature.rockwellautomation.com/idc/groups/literature/documents/rm/1770-rm516_-en-p.pdf

ADAM-4000 Protocol Specification:
<http://taiwan.advantech.com.tw/unzipfunc/Unzip/1-2CYUNZ/ADAM-4000%20manual%20Ed%2010.5.pdf>

EtherNet/IP Protocol Information:
<http://odva.org> , http://www.rockwellautomation.com/enabled/pdf/eipexp1_2.pdf

AUXILIARY DEVICES:

Analog Isolation and Input Modules – Dataforth Corporation
<http://dataforth.com/>

Solid State Relays – Power IO
<http://power-io.com/>

Solid State Relays – Crouzet / Crydom
<http://www.crydom.com>

Serial Displays - Scott Edwards Electronics:
http://seetron.com/vfd420_1.htm | <http://seetron.com/vfdmnl/mnl.htm>

THIRD PARTY SOFTWARE:

'Simply Modbus' Data Communication Test Software
<http://simplymodbus.ca>

'HyperTerminal' Terminal Emulation Software:
<http://hilgraeve.com>

'PuTTY' Terminal Emulation Software:
<http://www.putty.org>

"Tera Term" Terminal Emulation Software:
<http://tssh2.sourceforge.jp/index.html.en>

23 **LIMITED WARRANTY**

SCADAMETRICS LIMITED WARRANTY

1.0 GENERAL TERMS:

- 1.1 This Limited Warranty is extended only to the original end-user purchaser (CUSTOMER) and is not transferable.
- 1.2 No agent, reseller, or business partner of SCADAmetrics is authorized to modify the terms of this Limited Warranty on behalf of SCADAmetrics.
- 1.3 This Limited Warranty expressly excludes any product that has not been purchased as new from SCADAmetrics or its authorized reseller.
- 1.4 This Limited Warranty is only applicable in the country or territory where the product is intended for use.
- 1.5 SCADAmetrics warrants to the CUSTOMER that the products will be free from defects in workmanship and materials, under normal use and service, for TWO (2) YEARS from the date of purchase.
- 1.6 SCADAmetrics' sole obligation under this warranty shall be, at SCADAmetrics' sole discretion, to repair the defective product or part with new or reconditioned parts; or to exchange the defective product or part with a new or reconditioned product or part that is the same or similar. All products or parts that are exchanged for replacement will become the property of SCADAmetrics.
- 1.7 SCADAmetrics makes no warranty or representation that this product will work in combination with any hardware or software products provided by the CUSTOMER or third parties.
- 1.8 SCADAmetrics makes no warranty or representation that the operation of the software products provided with this product will be uninterrupted or error free.
- 1.9 SCADAmetrics shall not be responsible for any software or other CUSTOMER data that is installed onto interconnected computer(s).
- 1.10 SCADAmetrics shall not be responsible for any hardware or other components that is interconnected with SCADAmetrics components by the CUSTOMER or third parties.

2.0 OBTAINING WARRANTY SERVICE:

- 2.1 CUSTOMER must contact SCADAmetrics Technical Support or authorized SCADAmetrics Service Personnel within the applicable warranty period to obtain warranty service authorization.
- 2.2 To contact SCADAmetrics Technical Support, please call (636)405-7101 or email support@scadаметrics.com. For up-to-date telephone numbers and/or email addresses, please see the SCADAmetrics corporate web site at: www.scadаметrics.com
- 2.3 CUSTOMER should have the following information/items readily available when contacting SCADAmetrics:
1. MAC ID of the EtherMeter experiencing the problem.
 2. A description of the problem.
 3. Make and Model Numbers of Interconnected Meter Register(s).
 4. Make and Model Numbers of Interconnected Auxiliary I/O Sensor(s).
 5. Wiring Diagram of the EtherMeter experiencing the problem.
 6. Screen snapshot(s) of Meter Troubleshooting Display.
 7. The date and time when the problem first occurred.
 8. SCADA/Telemetry history tabulations/data that provide insight into the problem.

3.0 WARRANTY REPLACEMENT:

- 3.1 In the event SCADAmetrics Technical Support or its authorized Service Personnel determines the product or part has a malfunction or failure attributable directly to faulty workmanship and/or materials; and the product is within the TWO (2) YEAR warranty term, then SCADAmetrics will commence a warranty repair or replacement.
- 3.2 The warranty covers the repair or replacement of defective component(s) within the EtherMeter. The warranty does not cover costs associated with the retrieval, inbound shipping, and re-installation of the defective component(s). For warranty repaired/replaced components, SCADAmetrics shall cover the cost of ground shipping from SCADAmetrics to the end user.
- 3.3 Products or parts shipped to SCADAmetrics without prior authorization will not be accepted.
- 3.4 CUSTOMER agrees to insure the product or assume the risk of loss or damage that may occur in transit; and to use a shipping container equivalent to the original packaging.

3.5 Responsibility for loss or damage does not transfer to SCADAmetrics until the returned product or part is received at a designated SCADAmetrics facility.

3.6 Once a component has been visually inspected and tested, SCADAmetrics will, at its sole discretion, repair or replace, using new or reconditioned product or parts, to whatever extent it deems necessary to restore the product or part to operating condition.

3.7 SCADAmetrics shall not be liable for any damages caused by delay in delivering or furnishing repaired or replaced product or part.

4.0 LIMITATIONS:

4.1 THIRD-PARTY SOFTWARE: This SCADAmetrics product may include or be bundled with third-party software unrelated to the EtherMeter, the use of which is governed by separate end-user license agreements provided by third-party software vendors. This SCADAmetrics Limited Warranty does not apply to such third-party software. For the applicable warranty refer to the end-user license agreement governing the use of such software.

4.2 DAMAGE DUE TO MISUSE, NEGLIGENCE, NON-COMPLIANCE, AND/OR "ACTS OF GOD": To the extent permitted by applicable law, this SCADAmetrics Limited Warranty does not apply to normal wear and tear; damage or loss of data due to interoperability with third-party software/hardware not supplied by SCADAmetrics; alterations (by persons other than SCADAmetrics or its designees); damage caused by operator error or non-compliance with instructions as set out in the user documentation or other accompanying documentation; damage caused by acts of nature such as lightning, storms, floods, fires, and earthquakes, etc., damage or loss of data caused by a computer virus, worm, Trojan horse, or memory content corruption; failures of the product which result from accident, abuse, misuse (including but not limited to connection to incorrect voltages, and power points); failures caused by products not supplied by SCADAmetrics; damage caused by high voltage surges, shipping, or abnormal working conditions.

4.3 THE DEVICE IS NOT INTENDED FOR USE IN THE OPERATION OF NUCLEAR FACILITIES, AIRCRAFT NAVIGATION OR COMMUNICATION SYSTEMS, AIR TRAFFIC CONTROL SYSTEMS, LIFE SUPPORT MACHINES OR OTHER EQUIPMENT IN WHICH THE FAILURE OF THE SOFTWARE COULD LEAD TO DEATH, PERSONAL INJURY, PROPERTY DAMAGE, OR SEVERE PHYSICAL OR ENVIRONMENTAL DAMAGE. TO THE FULL EXTENT ALLOWED BY LAW, THE FOREGOING WARRANTIES AND REMEDIES ARE EXCLUSIVE AND ARE IN LIEU OF ALL OTHER WARRANTIES, TERMS, OR CONDITIONS, EXPRESS OR IMPLIED, EITHER IN FACT OR BY OPERATION OF LAW, STATUTORY OR OTHERWISE, INCLUDING WARRANTIES, TERMS, OR CONDITIONS OF MERCHANTABILITY, FITNESS FOR A PARTICULAR PURPOSE, SATISFACTORY QUALITY, CORRESPONDENCE WITH DESCRIPTION, AND NON-INFRINGEMENT, ALL OF WHICH ARE EXPRESSLY DISCLAIMED. SCADAMETRICS NEITHER ASSUMES NOR AUTHORIZES ANY OTHER PERSON TO ASSUME FOR IT ANY OTHER LIABILITY IN CONNECTION WITH THE SALE, INSTALLATION, MAINTENANCE, WARRANTY, OR USE OF ITS PRODUCTS.

4.4 LIMITATION OF LIABILITY. TO THE FULL EXTENT ALLOWED BY LAW, SCADAMETRICS ALSO EXCLUDES FOR ITSELF AND ITS SUPPLIERS ANY LIABILITY, WHETHER BASED IN CONTRACT OR TORT (INCLUDING NEGLIGENCE), FOR INCIDENTAL, CONSEQUENTIAL, INDIRECT, SPECIAL, OR PUNITIVE DAMAGES OF ANY KIND, OR FOR LOSS OF REVENUE OR PROFITS, LOSS OF BUSINESS, LOSS OF INFORMATION OR DATA, OR OTHER FINANCIAL LOSS ARISING OUT OF OR IN CONNECTION WITH THE SALE, INSTALLATION, MAINTENANCE, USE, PERFORMANCE, FAILURE, OR INTERRUPTION OF ITS PRODUCTS, EVEN IF SCADAMETRICS OR ITS AUTHORIZED RESELLER HAS BEEN ADVISED OF THE POSSIBILITY OF SUCH DAMAGES, AND LIMITS ITS LIABILITY TO REPAIR OR REPLACEMENT AT SCADAMETRICS' OPTION. THIS DISCLAIMER OF LIABILITY FOR DAMAGES WILL NOT BE AFFECTED IF ANY REMEDY PROVIDED HEREIN SHALL FAIL OF ITS ESSENTIAL PURPOSE.

5.0 DISCLAIMER:

Some countries, states, territories or provinces do not allow the exclusion or limitation of implied warranties or the limitation of incidental or consequential damages for certain products supplied to consumers, or the limitation of liability for personal injury, so the above limitations and exclusions may be limited in their application to CUSTOMER. When the implied warranties are not allowed by law to be excluded in their entirety, they will be limited to the TWO (2) YEAR duration of this written warranty. This warranty gives CUSTOMER specific legal rights, which may vary depending on local law.

6.0 GOVERNING LAW:

This Limited Warranty shall be governed by the laws of the State of Missouri, U.S.A. excluding its conflicts of laws principles and excluding the United Nations Convention on Contracts for the International Sale of Goods.

SCADAmetrics
1133 POND ROAD
WILDWOOD, MO 63038 USA

24 **FIRMWARE LICENSE**

SCADAMETRICS FIRMWARE LICENSE AGREEMENT

1. This agreement covers licensing terms for all firmware that is provided within computer memory that is a part of this EtherMeter Appliance.
2. This is an agreement between Licensor (SCADAmetrics) and Licensee, who is being licensed to use the SCADAmetrics Firmware Suite.
3. Licensee acknowledges that this is only a limited nonexclusive license. Licensor is and remains the owner of all titles, rights, and interests in the Firmware.
4. The firmware is integral to the EtherMeter appliance, and this License forbids the Licensee to install the Firmware on additional computers and/or devices. Licensee will not make copies of the Firmware or allow copies of the Firmware to be made by others, unless authorized by this License Agreement.
5. This License forbids the decompilation, disassembly, reverse engineering or modification the Firmware or any portion of it; and this License forbids any attempt to bypass, unlock, or disable any protective or initialization system on the Firmware.
6. This Firmware is subject to a limited warranty. Licensor warrants to Licensee that the physical medium on which this Firmware is distributed is free from defects in materials and workmanship under normal use, the Firmware will perform according to its printed documentation, and to the best of Licensor's knowledge Licensee's use of this Firmware according to the printed documentation is not an infringement of any third party's intellectual property rights. This limited warranty lasts for a period of TWO (2) YEARS after delivery. To the extent permitted by law, THE ABOVE-STATED LIMITED WARRANTY REPLACES ALL OTHER WARRANTIES, EXPRESS OR IMPLIED, AND LICENSOR DISCLAIMS ALL IMPLIED WARRANTIES INCLUDING ANY IMPLIED WARRANTY OF TITLE, MERCHANTABILITY, NONINFRINGEMENT, OR OF FITNESS FOR A PARTICULAR PURPOSE. No agent of Licensor is authorized to make any other warranties or to modify this limited warranty. Any action for breach of this limited warranty must be commenced within ONE (1) YEAR of the expiration of the warranty. Because some jurisdictions do not allow any limit on the length of an implied warranty, the above limitation may not apply to this Licensee. If the law does not allow disclaimer of implied warranties, then any implied warranty is limited to TWO (2) YEARS after delivery of the Firmware to Licensee. Licensee has specific legal rights pursuant to this warranty and, depending on Licensee's jurisdiction, may have additional rights.
7. In case of a breach of the Limited Warranty, Licensee's exclusive remedy is as follows: Licensee will return all copies of the Firmware to Licensor, at Licensee's cost, along with proof of purchase. (Licensee can obtain a step-by-step explanation of this procedure, including a return authorization code, by contacting Licensor at 1133 POND ROAD, WILDWOOD, MISSOURI 63038 USA (636)405-7101.) At Licensor's option, Licensor will either send Licensee a replacement copy of the Firmware, at Licensor's expense, or issue a full refund.
8. Notwithstanding the foregoing, LICENSOR IS NOT LIABLE TO LICENSEE FOR ANY DAMAGES, INCLUDING COMPENSATORY, SPECIAL, INCIDENTAL, EXEMPLARY, PUNITIVE, OR CONSEQUENTIAL DAMAGES, CONNECTED WITH OR RESULTING FROM THIS LICENSE AGREEMENT OR LICENSEE'S USE OF THIS FIRMWARE. Licensee's jurisdiction may not allow such a limitation of damages, so this limitation may not apply.
9. Licensee agrees to defend and indemnify Licensor and hold Licensor harmless from all claims, losses, damages, complaints, or expenses connected with or resulting from Licensee's business operations.
10. Licensor has the right to terminate this License Agreement and Licensee's right to use this Firmware upon any material breach by Licensee.
11. Licensee agrees to return to Licensor or to destroy all copies of the Firmware upon termination of the License.
12. This License Agreement is the entire and exclusive agreement between Licensor and Licensee regarding this Firmware. This License Agreement replaces and supersedes all prior negotiations, dealings, and agreements between Licensor and Licensee regarding this Firmware.
13. This License Agreement is governed by the law of MISSOURI applicable to MISSOURI contracts.
14. This License Agreement is valid without Licensor's signature. It becomes effective upon the earlier of Licensee's signature or Licensee's use of the Firmware.

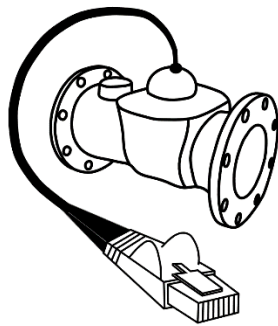

This Page Intentionally Blank.